

# AMC



## User Manual

Wall-hung gas condensing boilers

AMC 25/28 BIC  
AMC 25/39 BIC  
Diematic Evolution

**Dear Customer,**

Thank you very much for buying this appliance.

Please read through the manual carefully before using the product, and keep it in a safe place for later reference. In order to ensure continued safe and efficient operation we recommend that the product is serviced regularly. Our service and customer service organisation can assist with this.

We hope you enjoy years of problem-free operation with the product.

# Contents

<b>1</b>	<b>Safety</b>	<b>5</b>
1.1	General safety instructions	5
1.2	Recommendations	6
1.3	Liabilities	7
1.3.1	User's liability	7
1.3.2	Installer's liability	8
1.3.3	Manufacturer's liability	8
<b>2</b>	<b>About this manual</b>	<b>9</b>
2.1	General	9
2.2	Additional documentation	9
2.3	Symbols used	9
2.3.1	Symbols used in the manual	9
<b>3</b>	<b>Technical specifications</b>	<b>10</b>
3.1	Homologations	10
3.1.1	Certifications	10
3.2	Technical data	10
<b>4</b>	<b>Description of the product</b>	<b>12</b>
4.1	General description	12
4.2	Operating principle	12
4.2.1	Gas/air regulation	12
4.2.2	Combustion	12
4.2.3	Heating and domestic hot water production	12
4.2.4	Automatic refill device	13
4.3	Control panel description	13
4.3.1	Description of the components	13
4.3.2	Description of the home screen	13
4.3.3	Description of the main menu	13
4.3.4	Definition of zone	15
4.3.5	Definition of activity	15
<b>5</b>	<b>Operation</b>	<b>16</b>
5.1	Use of the control panel	16
5.1.1	Changing the display settings	16
5.1.2	Changing the name and symbol of a zone	16
5.1.3	Changing the name of an activity	16
5.1.4	Switching the central heating on or off	17
5.2	Start-up	17
5.3	Shutdown	17
5.4	Frost protection	17
<b>6</b>	<b>Settings</b>	<b>19</b>
6.1	List of parameters	19
6.1.1	CU-GH08 control unit settings	19
6.1.2	SCB-05 PCB settings	20
6.2	Changing the room temperature of a zone	21
6.2.1	Changing the operating mode of a zone	21
6.2.2	Changing the room temperature temporarily	22
6.2.3	Timer program to control the room temperature	22
6.3	Changing the domestic hot water temperature	23
6.3.1	Changing the domestic hot water operating mode	23
6.3.2	Increasing the domestic hot water temperature temporarily	23
6.3.3	Changing the comfort and reduced hot water temperature	23
6.3.4	Timer program to control the DHW temperature	23
6.4	Activating all holiday programs	24
<b>7</b>	<b>Maintenance</b>	<b>25</b>
7.1	General	25
7.2	Maintenance instructions	25
7.3	Refilling the system	25
7.3.1	Refilling the system with the automatic refill device	25
7.3.2	Activating the automatic refill device	26

- 7.4 Venting the system ..... 27
- 7.5 Draining the installation ..... 28
- 8 Troubleshooting ..... 29**
  - 8.1 Error codes ..... 29
    - 8.1.1 Warning ..... 29
    - 8.1.2 Blocking ..... 29
    - 8.1.3 Lock-out ..... 29
    - 8.1.4 Reporting error codes ..... 29
  - 8.2 Reading the installer's name and phone number ..... 29
  - 8.3 Problems and solutions ..... 30
- 9 Disposal ..... 31**
  - 9.1 Disposal and recycling ..... 31
- 10 Environmental ..... 32**
  - 10.1 Energy saving ..... 32
    - 10.1.1 Room thermostats and settings ..... 32
- 11 Warranty ..... 33**
  - 11.1 General ..... 33
  - 11.2 Terms of warranty ..... 33
- 12 Appendix ..... 34**
  - 12.1 ErP information ..... 34
    - 12.1.1 Product fiche ..... 34
    - 12.1.2 Package fiche ..... 35

# 1 Safety

## 1.1 General safety instructions

---

**Danger**

If you smell gas:

1. Do not use naked flames, do not smoke and do not operate electrical contacts or switches (doorbell, lighting, motor, lift etc).
2. Shut off the gas supply.
3. Open the windows.
4. Evacuate the property.
5. Contact a qualified installer.

**Danger**

If you smell flue gases:

1. Switch the boiler off.
2. Open the windows.
3. Evacuate the property.
4. Contact a qualified installer.

**Warning**

Do not touch the flue gas pipes. Depending on the boiler settings, the temperature of the flue gas pipes can rise to over 60°C.

**Warning**

Do not touch radiators for long periods. Depending on the boiler settings, the temperature of the radiators can rise to over 60°C.

**Warning**

Be careful when using the domestic hot water. Depending on the boiler settings, the temperature of domestic hot water can rise to over 65°C.

**Warning**

The use of the boiler and the installation by you as the end-user must be limited to the operations described in this manual. All other actions may only be undertaken by a qualified fitter/engineer.

**Warning**

The condensation drain must not be changed or sealed. If a condensate neutralisation system is used, the system must be cleaned regularly in accordance with the instructions provided by the manufacturer.



**Caution**

Ensure that the boiler is regularly serviced. Contact a qualified installer or arrange a maintenance contract for the servicing of the boiler.



**Caution**

Only genuine spare parts may be used.



**Important**

Regularly check for the presence of water and pressure in the heating installation.

## 1.2 Recommendations

---



**Danger**

This appliance can be used by children aged eight and above and people with a physical, sensory or mental disability, or with a lack of experience and knowledge, provided they are supervised and instructed in how to use the appliance in a safe manner and understand the associated dangers. Children must not be allowed to play with the appliance. Cleaning and user maintenance should not be carried out by children without adult supervision.



**Warning**

The installation and maintenance of the boiler must be undertaken by a qualified installer in accordance with the information in the supplied manual, doing otherwise may result in dangerous situations and/or bodily injury.



**Warning**

Only qualified persons are authorised to assemble, install and maintain the installation.



**Warning**

Removal and disposal of the boiler must be carried out by a qualified installer in accordance with local and national regulations.



**Warning**

If the mains lead is damaged, it must be replaced by the original manufacturer, the manufacturer's dealer or another suitably skilled person to prevent hazardous situations from arising.

**Danger**

For safety reasons, we recommend fitting smoke and CO alarms at suitable places in your home.

**Caution**

- Make sure the boiler can be reached at all times.
- The boiler must be installed in a frost-free area.
- If the power cord is permanently connected, you must always install a main bipolar switch with an opening gap of at least 3 mm (EN 60335-1).
- Drain the boiler and central heating system if you are not going to use your home for a long time and there is a chance of frost.
- The frost protection does not work if the boiler is out of operation.
- The boiler protection only protects the boiler, not the system.
- Check the water pressure in the system regularly. If the water pressure is lower than 0.8 bar, the system must be topped up (recommended water pressure between 1.5 and 2 bar).

**Important**

Keep this document near to the boiler.

**Important**

Instruction and warning labels must never be removed or covered and must be clearly legible throughout the entire service life of the boiler. Damaged or illegible instructions and warning stickers must be replaced immediately.

**Important**

Modifications to the boiler require the written approval of **De Dietrich**.

## 1.3 Liabilities

---

### 1.3.1 User's liability

---

To guarantee optimum operation of the system, you must abide by the following instructions:

- Read and follow the instructions given in the manuals provided with the appliance.
- Call on a qualified professional to carry out installation and initial commissioning.
- Get your installer to explain your installation to you.

- Have the required inspections and maintenance carried out by a qualified installer.
- Keep the instruction manuals in good condition close to the appliance.

### 1.3.2 Installer's liability

---

The installer is responsible for the installation and initial commissioning of the appliance. The installer must observe the following instructions:

- Read and follow the instructions given in the manuals provided with the appliance.
- Install the appliance in compliance with prevailing legislation and standards.
- Carry out initial commissioning and any checks necessary.
- Explain the installation to the user.
- If maintenance is necessary, warn the user of the obligation to check the appliance and keep it in good working order.
- Give all the instruction manuals to the user.

### 1.3.3 Manufacturer's liability

---

Our products are manufactured in compliance with the requirements of the various Directives applicable. They are therefore delivered with the CE marking and any documents necessary. In the interests of the quality of our products, we strive constantly to improve them. We therefore reserve the right to modify the specifications given in this document.

Our liability as manufacturer may not be invoked in the following cases:

- Failure to abide by the instructions on installing and maintaining the appliance.
- Failure to abide by the instructions on using the appliance.
- Faulty or insufficient maintenance of the appliance.



## 2 About this manual

### 2.1 General

---

This manual is intended for the end user of a AMC boiler.

**Important**

The manual is also available on our internet site.

### 2.2 Additional documentation

---

The following documentation is available in addition to this manual:

- Installation and service manual

### 2.3 Symbols used

---

#### 2.3.1 Symbols used in the manual

---

This manual uses various symbols to draw attention to special instructions. We do this to improve user safety, to prevent problems and to guarantee correct operation.

**Danger**

Risk of dangerous situations that may result in serious personal injury.

**Warning**

Risk of dangerous situations that may result in minor personal injury.

**Caution**

Risk of material damage.

**Important**

Please note: important information.

**See**

Reference to other manuals or pages in this manual.

## 3 Technical specifications

### 3.1 Homologations



#### 3.1.1 Certifications

Tab.1 Certifications

CE identification number	<b>PIN 0063CR3604</b>
Class NOx <sup>(1)</sup>	<b>6</b>
Type of connection	B <sub>23</sub> , B <sub>23P</sub> , B <sub>33</sub> C <sub>13(X)</sub> , C <sub>33(X)</sub> , C <sub>43P</sub> , C <sub>53(X)</sub> , C <sub>63(X)</sub> , C <sub>93(X)</sub> , C <sub>(10)3(X)</sub> , C <sub>(12)3(X)</sub>
(1) EN 15502-1	

### 3.2 Technical data

Tab.2 General

AMC			25/28 BIC	25/39 BIC
Nominal output (Pn) for central heating operation (80 °C/60 °C)	min-max  <sup>(1)</sup>	kW	5.0 - 24.8 19.9	7.0 - 24.8 24.8
Nominal output (Pn) for DHW operation	min-max  <sup>(1)</sup>	kW	5.0 - 29.1 29.1	7.0 - 38.5 38.5
(1) Factory setting				

Tab.3 Details of gas and flue gas

AMC			25/28 BIC	25/39 BIC
Gas consumption G20 (H gas)	min-max	m <sup>3</sup> /h	0.55 - 3.10	0.77 - 4.11
Gas consumption G25 (L gas)	min-max	m <sup>3</sup> /h	0.64 - 3.61	0.90 - 4.78
Gas consumption G31 (propane)	min-max	m <sup>3</sup> /h	0.24 - 1.20	0.30 - 1.59
NOx annual emissions G20 (H gas) EN15502	O <sub>2</sub> = 0%	ppm	16	-
NOx annual emissions G20 (H gas) EN15502	H <sub>l</sub>	mg/kWh	28	46
NOx annual emissions G20 (H gas) EN15502	H <sub>s</sub>	mg/kWh	25	41

Tab.4 Central heating circuit data

AMC			25/28 BIC	25/39 BIC
Water content		l	1.8	2.4
Water operating pressure (PMS)	max	bar	3.0	3.0
Water temperature	max	°C	110.0	110.0
Operating temperature	max	°C	90.0	90.0

Tab.5 DHW circuit data

AMC			25/28 BIC	25/39 BIC
Specific hot water flow rate D (60°C)		l/min	8.2	11
Specific hot water flow rate D (40°C)		l/min	20	24
Flow rate threshold <sup>(1)</sup>	max	l/min	0	0
Operating pressure (Pmw)		bar	8	8
(1) Minimum amount of water that comes out of the tap to make the boiler start.				

Tab.6 Electrical data

AMC			25/28 BIC	25/39 BIC
Supply voltage		V~	230	230
Power consumption – full load	max  <sup>(1)</sup>	W	125 68	146 71
(1) Factory setting.				

Tab.7 Other data

AMC			25/28 BIC	25/39 BIC
Total weight (empty)		kg	65	60

Tab.8 Technical parameters

AMC			25/28 BIC	25/39 BIC
Condensing boiler			Yes	Yes
Low-temperature boiler <sup>(1)</sup>			No	No
B1 boiler			No	No
Cogeneration space heater			No	No
Combination heater			Yes	Yes
<b>Rated heat output</b>	<i>P<sub>rated</sub></i>	kW	25	35
Useful heat output at nominal heat output and high temperature operation <sup>(2)</sup>	<i>P<sub>4</sub></i>	kW	24.8	24.8
Useful heat output at 30% of rated heat output and low temperature regime <sup>(1)</sup>	<i>P<sub>1</sub></i>	kW	8.3	8.2
<b>Seasonal space heating energy efficiency</b>	<i>η<sub>s</sub></i>	%	94	92
Useful efficiency at rated heat output and high temperature regime <sup>(2)</sup>	<i>η<sub>4</sub></i>	%	89.4	87.8
Useful efficiency at 30% of rated heat output and low temperature regime <sup>(1)</sup>	<i>η<sub>1</sub></i>	%	99.2	99.6
<b>Auxiliary electricity consumption</b>				
Full load	<i>el<sub>max</sub></i>	kW	0.037	0.028
Part load	<i>el<sub>min</sub></i>	kW	0.017	0.018
Standby mode	<i>P<sub>SB</sub></i>	kW	0.004	0.004
<b>Other items</b>				
Standby heat loss	<i>P<sub>stby</sub></i>	kW	0.071	0.071
Ignition burner power consumption	<i>P<sub>ign</sub></i>	kW	-	-
Annual energy consumption	<i>Q<sub>HE</sub></i>	GJ	76	78
Sound power level, indoors	<i>L<sub>WA</sub></i>	dB(A)	50	46
Emissions of nitrogen oxides	NO <sub>x</sub>	mg/kWh	25	41
<b>Domestic hot water parameters</b>				
<b>Declared load profile</b>			B	B
Daily electricity consumption	<i>Q<sub>elec</sub></i>	kWh	0.293	0.294
Annual electricity consumption	<i>AEC</i>	kWh	64	65
<b>Water heating energy efficiency</b>	<i>η<sub>wh</sub></i>	%	-	-
Daily fuel consumption	<i>Q<sub>fuel</sub></i>	kWh	31.083	30.072
Annual fuel consumption	<i>AFC</i>	GJ	25	24
(1) Low temperature means 30°C for condensing boilers, 37°C for low temperature boilers and 50°C (at heater inlet) for other heating appliances.				
(2) High temperature operation means 60°C return temperature at heater inlet and 80°C feed temperature at heater outlet.				



See

See the back of this manual for contact information.

## 4 Description of the product

### 4.1 General description

The AMC boiler is a wall-mounted gas boiler with the following characteristics:

- High-efficiency heating
- Low polluting emissions
- Automatic refill device
- High-quality electronic control panel
- Easier installation and connection thanks to the mounting frame delivered with the appliance.

The following boiler types are available:

Type	Mode
AMC 25/28 BIC AMC 25/39 BIC	Heating and domestic hot water production with integrated calorifier.

### 4.2 Operating principle

#### 4.2.1 Gas/air regulation

The boiler is equipped with a casing that also serves as an air box. The fan draws in the combustion air. The gas is injected into the venturi and mixed with the combustion air. The fan speed is controlled on the basis of the settings, the heat demand and the prevailing temperatures measured by the temperature sensors. The gas/air ratio control ensures an accurate mixture of the required amounts of gas and air. This provides optimum combustion over the entire heat input range. The gas/air mixture goes to the burner, where it is ignited by the ignition electrode.

#### 4.2.2 Combustion

The burner heats the central heating water flowing through the heat exchanger. If the temperature of the flue gases is lower than the dew point (approx. 55°C), the water vapour condenses in the heat exchanger. The heat released during this condensation process (referred to as the latent or condensation heat) is also transferred to the central heating water. The cooled flue gases are discharged through the flue gas discharge pipe. The condensed water is discharged through a siphon.

#### 4.2.3 Heating and domestic hot water production

On heating and domestic hot water production type boilers, an integrated plate heat exchanger heats the domestic water. A three-way valve determines whether heated water flows to the central heating installation or to the plate heat exchanger. A temperature sensor in the boiler tank signals a temperature drop when draining hot water. The sensor sends a signal to the control unit which ensures that the boiler produces hot tap water. If the boiler is in standby mode, the three-way valve is switched to the plate heat exchanger. The pump and the boiler are then switched on. If the boiler is in CH mode, the three-way valve is toggled. The three-way valve is spring-loaded but only consumes electricity when it switches to another position.

The CH water heats the tap water in the plate heat exchanger. This water is pumped into the boiler tank to provide a constant plentiful supply of domestic hot water. If no hot water is drawn off, the boiler reheats the plate exchanger and the boiler tank at regular intervals. Any limescale particles are kept out of the plate heat exchanger by a water filter, which cleans itself once every 76 hours.

#### 4.2.4 Automatic refill device

The boiler has an automatic refill device located under the boiler.

The automatic refill device will refill the central heating system whenever the water pressure is lower than the set minimum. Refilling can be automatic or semi-automatic. On the semi-automatic setting, refilling will only start after confirmation by the user. The automatic refill device can also be used to fill an empty system.

If refilling takes too long or occurs too often (e.g. because the system leaks), a warning code will appear on the display and refilling will stop.

### 4.3 Control panel description

Fig.1 Components of the control panel

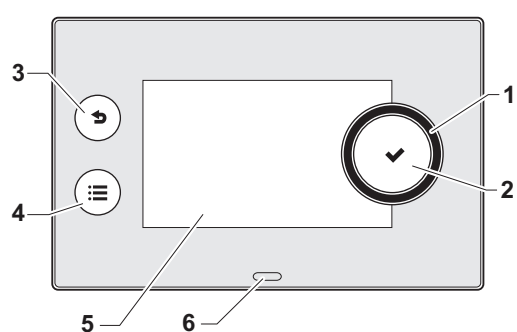

AD-3000932-01

#### 4.3.1 Description of the components

- 1 Rotary knob to select a tile, menu or setting
- 2 Button ✓ to confirm the selection
- 3 Back button ↶ to return to the previous level or previous menu
- 4 Menu button ≡ to return to the main menu
- 5 Display
- 6 LED for status indication:
  - continuous green = normal operation
  - flashing green = warning
  - continuous red = shutdown
  - flashing red = lockout

#### 4.3.2 Description of the home screen

This screen is shown automatically after start-up of the appliance. The control panel goes automatically in standby mode (black screen) if the screen is not touched for 5 minutes. Press one of the buttons on the control panel to activate the screen again.

You can navigate from any menu to the home screen by pressing the back button ↶ for several seconds.

The tiles on the home screen provide quick access to the corresponding menus. Use the rotary knob to navigate to the menu of your choice and press the button ✓ to confirm the selection.

Fig.2 Icons on home screen

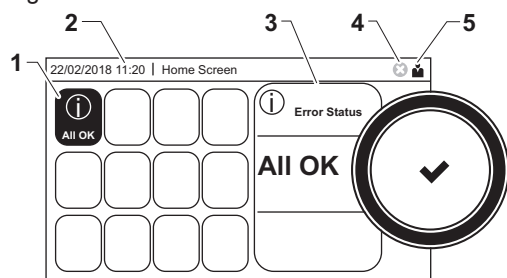

AD-3001157-01

- 1 Tiles: the selected tile is highlighted
- 2 Date and time | Name of the screen (actual position in the menu)
- 3 Information about the selected tile
- 4 Error indicator (only visible if an error has been found)
- 5 Icon showing the navigation level:

- 🏠: Chimney sweeper level
- 👤: User level
- 🛠️: Installer level

The installer level is protected by an access code. When this level is active, the status of the tile [🛠️] changes from **Off** into **On**.

#### 4.3.3 Description of the main menu

You can navigate from any menu directly to the main menu by pressing the menu button ≡. The number of accessible menus depends on the access level (user or installer).

Fig.3 Items in the main menu

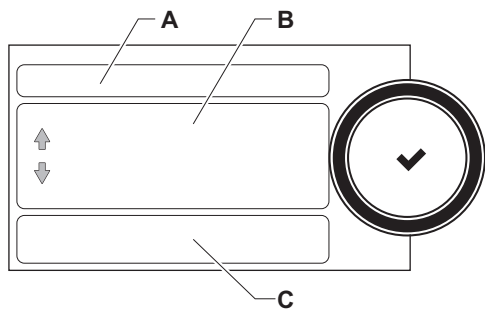

AD-3000935-01

- A Date and time | Name of the screen (actual position in the menu)
- B Available menus
- C Brief explanation of the selected menu

Tab.9 Available menus for the user

Description	Icon
System Settings	
Version Information	<b>i</b>

Tab.10 Available menus for the installer

Description	Icon
Installation Setup	
Commissioning Menu	
Advanced Service Menu	
Error History	
System Settings	
Version Information	<b>i</b>

■ Meaning of the icons in the display

Tab.11 Icons

	User level	<b>i</b>	Information
	Installer level		Error display
	Chimney sweeper level		System settings
	Service		Water pressure
	Timer program		DHW 1
	Temporary overwrite of the timer program		DHW 2
	Holiday program		DHW boost on
	Manual		Gas boiler
	Energy-saving mode		Burner output level (1 to 5 bars, with each bar representing 20% output)
	Frost protection		Burner on
	Central heating on		Outside temperature sensor
	All zones (groups)		DHW tank
	Living room <sup>(1)</sup>		Solar calorifier
	Kitchen <sup>(1)</sup>		Cascade
	Bedroom <sup>(1)</sup>		Pump
	Study <sup>(1)</sup>		Three-way valve
	Cellar <sup>(1)</sup>		

(1) Adjustable icon for heating zone

Fig.4 Two zones

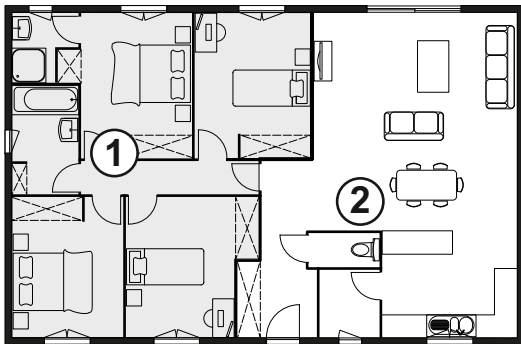

MW-1001145-2

#### 4.3.4 Definition of zone

Zone is the term given to the different hydraulic circuits CIRCA, CIRCB and so on. It designates several rooms of the house served by the same circuit.

Tab.12 Example of two zones

	Zone	Factory name
1	Zone 1	CIRCA
2	Zone 2	CIRCB



**For more information, see**

Changing the name and symbol of a zone, page 16

Fig.5 Activities of a timer program

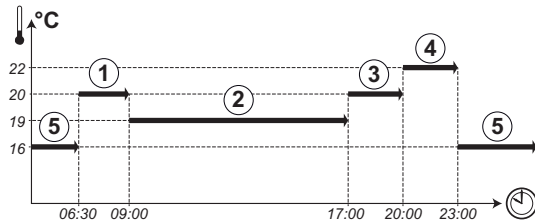

MW-1001144-2

#### 4.3.5 Definition of activity

Activity is the term used when programming time slots in a timer program. The timer program sets the room temperature for different activities during the day. A temperature setpoint is associated with each activity. The last activity of the day is valid until the first activity of the next day.

Tab.13 Example of activities

Start of the activity	Activity	Temperature setpoint
6:30	Morning (1)	20 °C
9:00	Away (2)	19 °C
17:00	Home (3)	20 °C
20:00	Evening (4)	22 °C
23:00	Sleep (5)	16 °C



**For more information, see**

Changing the name of an activity, page 16

## 5 Operation

### 5.1 Use of the control panel

#### 5.1.1 Changing the display settings





1. Press the  button.
2. Select **System Settings** .
3. Perform one of the operations described in the table below:

Tab.14 Display settings

System Settings menu	Settings
Set Date and Time	Set the current date and time
Select Country and Language	Select your country and language
Daylight Saving Time	Enable or disable daylight saving time
Installer Details	Enter the name and phone number of the installer
Set Heating Activity Names	Create the names for the activities of the timer program
Set Screen Brightness	Adjust the brightness of the screen
Set click sound	Enable or disable the click sound of the rotary knob
License Information	Read out detailed license information from the device platform application

#### 5.1.2 Changing the name and symbol of a zone

You can change the name and symbol of a zone.

1. Select the tile of the zone you want to change.
2. Select **Zone configuration**.
3. Select **Zone friendly Name**  
⇒ A keyboard with letters, numbers and symbols is shown.
4. Change the name of the zone (20 characters maximum):
  - 4.1. Press the rotary knob  to repeat a letter, number or symbol.
  - 4.2. Select  to delete a letter, number or symbol.
  - 4.3. Select  to add a space.
5. Select the  sign on the screen when the name is complete.
6. Press the rotary knob  to confirm the selection.
7. Select **Icon display zone**.
8. Change the symbol of the zone.



For more information, see  
Definition of zone, page 15

#### 5.1.3 Changing the name of an activity

You can change the names of the activities in the timer program.

1. Press the  button.
2. Select **System Settings** .
3. Select **Set Heating Activity Names**.  
⇒ A list of 6 activities and their standard names is shown:

Activity 1	Sleep
Activity 2	Home
Activity 3	Away
Activity 4	Morning
Activity 5	Evening
Activity 6	Custom

4. Select an activity.  
⇒ A keyboard with letters, numbers and symbols is shown.



5. Change the name of the activity:
  - 5.1. Press the rotary knob ✓ to repeat a letter, number or symbol.
  - 5.2. Select ← to delete a letter, number or symbol.
  - 5.3. Select ▢ to add a space.
6. Select the ✓ sign on the screen when the name is complete.
7. Press the rotary knob ✓ to confirm the selection.



**For more information, see**  
Definition of activity, page 15

#### 5.1.4 Switching the central heating on or off

You can switch off the central heating function of the boiler to save energy, for example during the summer period.

1. Select the tile [📄].
2. Select **CH function on**.
3. Select the following setting:
  - 3.1. **Off** to switch off the central heating function.
  - 3.2. **On** to switch the central heating function on again.

## 5.2 Start-up

Start the boiler up as follows:

1. Open the boiler gas tap.
2. Turn the boiler on
3. Turn on the boiler using the on/off switch.
4. The boiler will also start an automatic venting cycle lasting around 3 minutes.
5. Check the water pressure of the central heating system shown on the control panel display. If necessary, top up the central heating system.

The current operating condition of the boiler is shown by the status signal on the control panel.



**For more information, see**  
Refilling the system, page 25

## 5.3 Shutdown

If the central heating is not due to be used for a long period of time, it is recommended that the boiler be disconnected from the power supply.

1. Turn off the boiler using the on/off switch.
2. Shut off the gas supply.
3. Keep the area frost-free.

## 5.4 Frost protection



### Caution

- Switch the boiler off and drain it and the central heating system if you are not going to use your home or the building for a long time and there is a chance of frost
- The frost protection does not work if the boiler is out of operation.
- The built-in boiler protection is only activated for the boiler and not for the system and radiators.
- Open the valves of all the radiators connected to the system.

Set the temperature control low, for example to 10°C.

If the temperature of the central heating water in the boiler drops too low, the built-in boiler protection system is activated. This system works as follows:

- If the water temperature is lower than 7°C, the pump switches on.
- If the water temperature is lower than 4°C, the boiler switches on.
- If the water temperature is higher than 10°C, the boiler shuts down and the pump continues to run for a short time.

An external sensor can be connected to the boiler to prevent the system and radiators freezing in frost-sensitive areas (e.g. a garage).

## 6 Settings

### 6.1 List of parameters



#### Important

All possible options are indicated in the adjustment range. The display of the boiler only shows the relevant settings for the appliance.

#### 6.1.1 CU-GH08 control unit settings



#### Important

- All tables show the factory setting for the parameters.
- The tables also list parameters that are only applicable if the boiler is combined with other equipment such as an outdoor sensor or automatic refill device.

Tab.15 > Zone setup > CIRCA

Text display	Description	Adjustment range	25/28 BIC	25/39 BIC
Zone friendly Name	Friendly Name of the user zone		0	0
ZoneStartTimeHoliday	Zone Start Time holiday Mode		-	-
ZoneEndTime Holiday	Zone End Time of holiday Mode		-	-
ZoneEnd Change Mode	Zone End Time of change Mode		-	-
Tflow setpoint zone	Zone flow temperature setpoint, used when the zone is set to a fixed flow setpoint.	0 °C - 90 °C	80	80
User T.Room Activity	Room setpoint temperature of the user zone activity	5 °C - 30 °C	16	16
User T.Room Activity	Room setpoint temperature of the user zone activity	5 °C - 30 °C	20	20
User T.Room Activity	Room setpoint temperature of the user zone activity	5 °C - 30 °C	6	6
User T.Room Activity	Room setpoint temperature of the user zone activity	5 °C - 30 °C	21	21
User T.Room Activity	Room setpoint temperature of the user zone activity	5 °C - 30 °C	22	22
User T.Room Activity	Room setpoint temperature of the user zone activity	5 °C - 30 °C	20	20
Manu ZoneRoomTempSet	Manually setting the room temperature setpoint of the zone	5 °C - 30 °C	20	20
OperatingZoneMode	Operating mode of the zone	0 = Scheduling 1 = Manual 2 = Antifrost 3 = Temporary	1	1
Temporary Room Setp	Temporary room setpoint per zone	5 °C - 30 °C	20	20
Zone, fire place	Fire Place mode is active	0 = Off 1 = On	0	0
Icon display zone	Choice icon to display this zone	0 = None 1 = All 2 = Bedroom 3 = Livingroom 4 = Study 5 = Outdoor 6 = Kitchen 7 = Basement	3	3

Tab.16  > DHW setup

Text display	Description	Adjustment range	25/28 BIC	25/39 BIC
DHW timeprog. select	Time program selected for DHW.	0 = Schedule 1 1 = Schedule 2 2 = Schedule 3	0	0
DHW comfort setpoint	Comfort temperature setpoint from the Domestic Hot Water tank	40 °C – 65 °C	60	60
DHW reduced setpoint	Reduced temperature setpoint from the Domestic Hot Water tank	7 °C – 50 °C	15	15
End change mode	End change mode Time TimeStamp		-	-
DHW mode	DHW primary mode current working setting	0 = Scheduling 1 = Manual 2 = Antifrost 3 = Temporary		
DHW holiday setpoint	Holiday temperature setpoint from the Domestic Hot Water tank	10 °C – 60 °C	10	10

Tab.17  > Outdoor sensor setup

Text display	Description	Adjustment range	25/28 BIC	25/39 BIC
Summer Winter	Outdoor temperature: upper limit for heating	10 °C – 30 °C	22	22
Force summer mode	The heating is stopped. Hot water is maintained. Force Summer Mode	0 = Off 1 = On	0	0

Tab.18  > Shower time function

Text display	Description	Adjustment range	25/28 BIC	25/39 BIC
ShowerZone T warning	Time before Shower Zone is warning	0 Min – 180 Min	0	0
ShowerZoneTimeAction	Action when Shower Zone time has elapsed	0 = Off 1 = Warning 2 = Reduce DHW set point	0	0
DHWred Showerlimited	Reduced DHW setpoint during shower limitation of the zone	20 °C – 65 °C	40	40

Tab.19  > ( Gas fired appliance )

Text display	Description	Adjustment range	25/28 BIC	25/39 BIC
CH function on	Enable central heating heat demand processing	0 = Off 1 = On	1	1
DHW function on	Enable domestic hot water heat demand processing	0 = Off 1 = On	1	1

### 6.1.2 SCB-05 PCB settings



#### Important

The table shows the factory setting for the parameters.

Tab.20  > DHW setup > BIC

Text display	Description	Adjustment range	SCB-05
ZoneEndTime Holiday	Zone End Time of holiday Mode		-
ZoneEnd Change Mode	Zone End Time of change Mode		-
Postrun zone pump	Pump post runtime of the zone	0 Min - 20 Min	0

Text display	Description	Adjustment range	SCB-05
OperatingZoneMode	Operating mode of the zone	0 = Scheduling 1 = Manual 2 = Antifrost 3 = Temporary	1
ComfortZoneDHWtemp	Comfort Domestic Hot Water Temperature Setpoint of zone	40 °C - 65 °C	55
ReducedZoneDHWtemp.	Reduced Domestic Hot Water Temperature Setpoint of zone	15 °C - 40 °C	15
Holiday ZoneDHWtemp	Holiday Domestic Hot Water Temperature Setpoint of zone	0 °C - 40 °C	6
Antileg ZoneDHWtemp	Antilegionellosis Domestic Hot Water Temperature Setpoint of zone	55 °C - 70 °C	70
Start Antileg	Start time of the function Antilegionellosis	0 HoursMinutes - 255 HoursMinutes	138
Zone Dhw antileg.	Duration of the function Antilegionellosis	10 Min - 180 Min	10
ZoneTimeProg Select	Time Program of the zone selected by the user	0 = Schedule 1 1 = Schedule 2 2 = Schedule 3 3 = Cooling	0
StartdayAntileg zone	Startday of the function antilegionella of the zone	1 = Monday 2 = Tuesday 3 = Wednesday 4 = Thursday 5 = Friday 6 = Saturday 7 = Sunday	6
Icon display zone	Choice icon to display this zone	0 = None 1 = All 2 = Bedroom 3 = Livingroom 4 = Study 5 = Outdoor 6 = Kitchen 7 = Basement 8 = Swimming Pool 9 = DHW Tank 10 = DHW Electrical Tank 11 = DHW Layered Tank 12 = Internal Boiler Tank 13 = Time Program	0

## 6.2 Changing the room temperature of a zone

### 6.2.1 Changing the operating mode of a zone

To regulate the room temperature of the different areas of the house, you can choose from 5 operating modes:

1. Select the tile of the zone you want to change.  
⇒ The **Zone QuickSelect** menu opens.

2. Select the desired operating mode:

Tab.21 Operating modes

Icon	Mode	Description
	<b>Scheduling</b>	The room temperature is controlled by a timer program
	<b>Manual</b>	The room temperature is set to a fixed setting
	<b>Short temperature change</b>	The room temperature is changed temporarily
	<b>Holiday</b>	The room temperature is reduced during your holiday to save energy
	<b>Antifrost</b>	Protect the boiler and installation from freezing in winter

### 6.2.2 Changing the room temperature temporarily

Regardless of the operating mode selected for a zone, it is possible to change the room temperature for a short period of time. After this time period has elapsed, the selected operating mode resumes.

1. Select the tile of the zone you want to change.
2. Select **Short temperature change**
3. Set the duration in hours and minutes.
4. Set the temporary room temperature.
  - ⇒ The **Short temperature change** menu shows the duration and the temporary temperature.

### 6.2.3 Timer program to control the room temperature

#### ■ Creating a timer program to control the room temperature

A timer program allows you to vary the room temperature per hour and per day. The room temperature is linked to the activity of the timer program.



#### Important

You can create up to three timer programs per zone. For example, you can create a program for a week with normal working hours and a programme for a week when you are at home most of the time.

1. Select the tile of the zone you want to change.
2. Select **Zone configuration > Heating Schedule**.
3. Select the timer program you want to modify: **Schedule 1, Schedule 2 or Schedule 3**.
  - ⇒ Activities scheduled for Sunday are displayed. The last scheduled activity of a day is active until the first activity of the next day. At initial start-up, all weekdays have two standard activities; **Home** starting at 6:00 and **Sleep** starting at 22:00.
4. Select the weekday you want to modify.
  - A Weekday
  - B Overview of scheduled activities
  - C List of actions
5. Perform the following actions, if necessary:
  - 5.1. **Edit** the start time and/or activity of a scheduled activity.
  - 5.2. **Add** a new activity.
  - 5.3. **Delete** a scheduled activity (select the activity **Delete**).
  - 5.4. **Copy** the scheduled activities of the weekday to other days.
  - 5.5. **Change the temperature** linked to an activity.

Fig.6

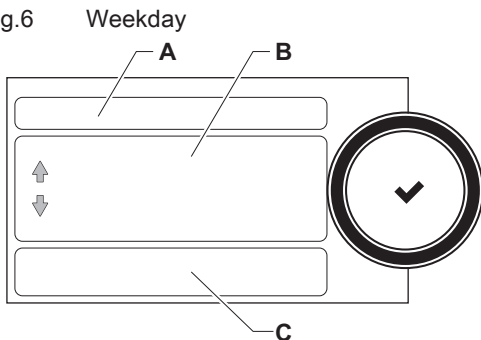

AD-3000935-01

#### ■ Activating a timer program

In order to use a timer program, it is necessary to activate the operating mode **Scheduling**. This activation is done separately for each zone.

1. Select the tile of the zone you want to change.

2. Select  **Scheduling**.
3. Select timer program **Schedule 1**, **Schedule 2** or **Schedule 3**.





## 6.3 Changing the domestic hot water temperature

### 6.3.1 Changing the domestic hot water operating mode

For hot water production, you can choose from 5 operating modes:



1. Select the tile .
  - ⇒ The **DHW QuickSelect** menu opens.
2. Select the desired operating mode:

Tab.22 DHW operating modes

Icon	Mode	Description
	<b>Scheduling</b>	The domestic hot water temperature is controlled by a timer program
	<b>Manual</b>	The domestic hot water temperature is set to a fixed setting
	<b>Hot water boost</b>	The domestic hot water temperature is increased temporarily
	<b>Holiday</b>	The domestic hot water temperature is reduced during your holiday to save energy
	<b>Antifrost</b>	Protect the boiler and installation from freezing in winter



### 6.3.2 Increasing the domestic hot water temperature temporarily

Regardless of the operating mode selected for domestic hot water production, it is possible to increase the domestic hot water temperature for a short period of time. After this time period the hot water temperature decreases to the **Reduced** setpoint.

1. Select the tile .
2. Select  **Hot water boost**
3. Set the duration in hours and minutes.
  - ⇒ The temperature is increased to the **DHW comfort setpoint**.

### 6.3.3 Changing the comfort and reduced hot water temperature

You can change the comfort and reduced hot water temperature in the timer program.

1. Select the tile .
2. Select  **Zone configuration > Domestic Hot Water Setpoints**.
3. Select the DHW setpoint you want to change:
  - 3.1. **DHW comfort setpoint**: The DHW temperature when the hot water production is switched on.
  - 3.2. **DHW reduced setpoint**: The DHW temperature when the hot water production is switched off.
4. Change the temperature of the selected setpoint

### 6.3.4 Timer program to control the DHW temperature

#### ■ Creating a timer program to control the domestic hot water temperature

A timer program allows you to vary the domestic hot water temperature per hour and per day. The hot water temperature is linked to the activity of the timer program.



#### Important

You can create up to three timer programs. For example, you can create a program for a week with normal working hours and a programme for a week when you are at home most of the time.

1. Select the tile [🏠].
2. Select ⚙️ **Zone configuration > DHW Schedule**.
3. Select the timer program you want to modify: **Schedule 1, Schedule 2** or **Schedule 3**.
  - ⇒ Activities scheduled for Sunday are displayed. The last scheduled activity of a day is active until the first activity of the next day. The scheduled activities are shown. At initial start-up, all weekdays have two standard activities; **Comfort** starting at 6:00 and **Reduced** starting at 22:00.
4. Select the weekday you want to modify.
  - A Weekday
  - B Overview of scheduled activities
  - C List of actions
5. Perform the following actions, if necessary:
  - 5.1. **Edit** the start time and/or activity of a scheduled activity.
  - 5.2. **Add** a new activity.
  - 5.3. **Delete** a scheduled activity (select the activity **Delete**).
  - 5.4. **Copy** the scheduled activities of the weekday to other days.
  - 5.5. **Change the temperature** linked to an activity.

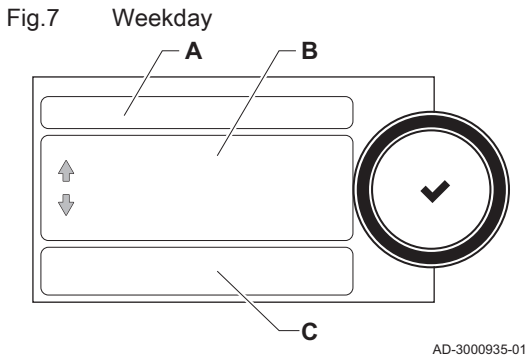

■ **Activating a DHW timer program**

In order to use a DHW timer program, it is necessary to activate the operating mode **Scheduling**. This activation is done separately for each zone.

1. Select the tile [🏠].
2. Select ⚙️ **Scheduling**.
3. Select DHW timer program **Schedule 1, Schedule 2** or **Schedule 3**.

**6.4 Activating all holiday programs**

If you go on holiday, the room temperature and domestic hot water temperature can be reduced to save energy. With the following procedure you can activate the holiday mode for all zones and domestic hot water temperature.

1. Select the tile [🏠].
2. Set the following parameters:

Tab.23 Holiday program settings

Parameter	Description
<b>Start date holiday</b>	Set the start time and date of your holiday
<b>End date holiday</b>	Set the end time and date of your holiday
<b>Wished room zone temperature on holiday period</b>	Set the room temperature for the holiday period
<b>Reset</b>	Reset or cancel the holiday program



## 7 Maintenance

### 7.1 General

- Perform the standard checking and maintenance procedures once a year.
- Perform the specific maintenance procedures if necessary.



#### Caution

- Maintenance operations must be completed by a qualified installer.
- We recommend taking out a maintenance contract.
- Replace defective or worn parts with original spare parts.
- An annual inspection is mandatory.

### 7.2 Maintenance instructions

1. Check the water pressure in the central heating system. If necessary, top up the central heating system.



#### Important

If the water pressure is lower than 0.8 bar, more water should be added. The recommended water pressure is between 1.5 and 2 bar.

2. Check radiators for leaks and (especially in damp areas) for rust.
3. Open and close the radiator valves several times a year to ensure they can still be rotated.
4. Clean the outside of the boiler using a damp cloth and a light detergent.



#### Caution

Only a qualified professional is authorised to clean the inside of the boiler.

### 7.3 Refilling the system

Fig.8 Automatic refill device

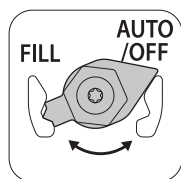

AD-0001352-01

The central heating system can be refilled (semi-)automatically using the automatic refill device.



#### See

Refilling the system with the automatic refill device, page 25



#### Important

- Semi-automatic (re)filling means: The boiler indicates that the system needs to be (re)filled and requests confirmation from the user.
- Automatic refilling means: The system is refilled as soon as the water pressure is too low.
- The installer can set the system to be refilled automatically or semi-automatically.

The automatic refill device can also be used to manually refill the central heating installation.

#### 7.3.1 Refilling the system with the automatic refill device

The automatic refill device is placed under the boiler. This device can refill a central heating system automatically or semi-automatically (after confirmation by the user) if the water pressure has decreased to a value lower than the set minimum water pressure. The system is refilled to the set maximum operating pressure.

Fig.9 AUTO position

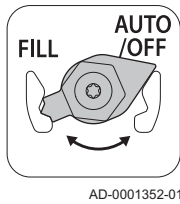

1. Check that the boiler is switched on.

**Caution**

The automatic refill device is only active if the boiler is switched on.

2. Check that the automatic refill device is on AUTO.
3. If the boiler is set to refill automatically, the user does not need to take any action if the water pressure is too low: refilling starts automatically.
4. If the boiler is set to refill semi-automatically, a message appears on the display if the water pressure is too low.
  - 4.1. Press the ✓ button to confirm the top-up.

**Important**

Refilling can only be interrupted if the water pressure is higher than 0.3 bar.

5. A message will appear on the display when automatic refilling is complete:
  - 5.1. Press the ↵ key to go back to the main display.

**Caution**

- The warning code **A02.33** will be displayed if refilling is taking too long. The boiler will continue to operate normally.
- The warning code **A02.34** will be displayed if the boiler needs to be refilled too often. The boiler will continue to operate normally.
- The boiler can interrupt refilling temporarily for normal heating activities such as producing hot tap water.

### 7.3.2 Activating the automatic refill device

If the boiler is fitted with an automatic refill device and the minimum water pressure is reached, the system is automatically topped up when in **Auto** mode. In **Manual** mode the boiler signals that filling is needed. If required, you can refill the system manually before the minimum water pressure is reached by activating the automatic refill device.

1. Select the tile [F<sub>bar</sub>].
2. Select **Start water filling**.
  - ⇒ The automatic refill device will top up your system until the maximum operational water pressure is reached.

## 7.4 Venting the system

Fig.10 Venting the system

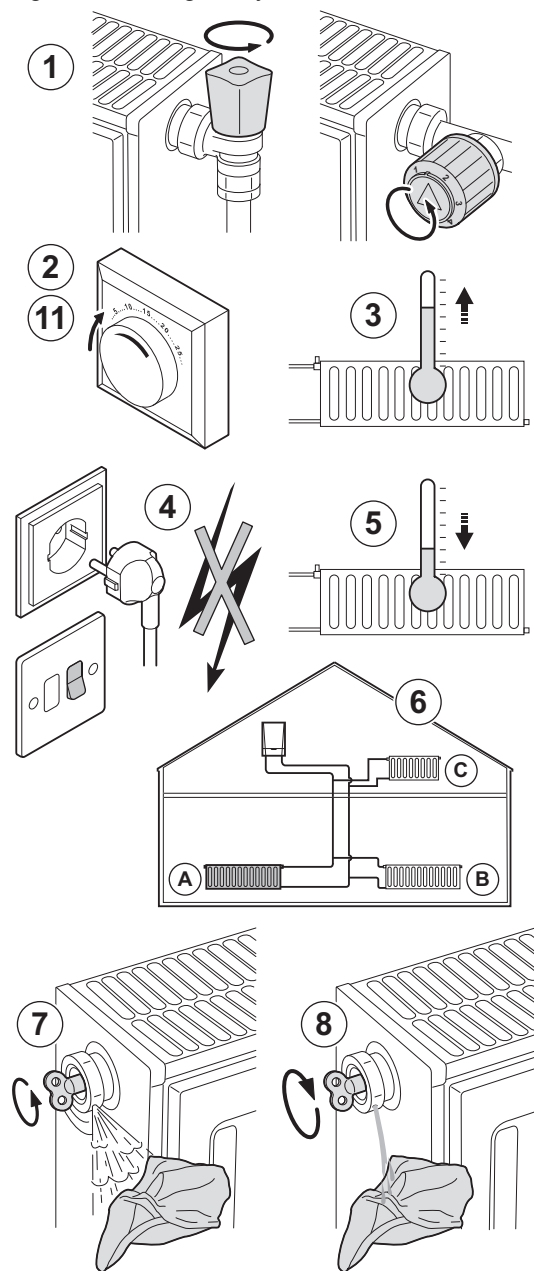

Any air in the boiler, the pipes or the valves must be removed in order to prevent unwanted noises that may occur during heating or when tapping water. To do this, proceed as follows:

1. Open the valves of all the radiators connected to the system.
2. Set the room thermostat to the highest possible temperature.
3. Wait until the radiators are warm.
4. Switch off the boiler.
5. Wait approximately 10 minutes, until the radiators feel cold.
6. Vent the radiators. Work from the lowest to the highest.
7. Open the venting valve with the bleed key, keeping a cloth pressed against the vent.



### Warning

The water may still be hot.

8. Wait until water comes out of the venting valve and then close the venting valve.
9. Turn on the boiler.  
⇒ A 3-minute venting cycle is performed automatically.
10. After venting, check that the water pressure in the system is still adequate. If necessary, top up the water level in the heating system.
11. Adjust the room thermostat or temperature control.



### For more information, see

Refilling the system, page 25

AD-3000484-B

## 7.5 Draining the installation

Fig.11 Draining the installation

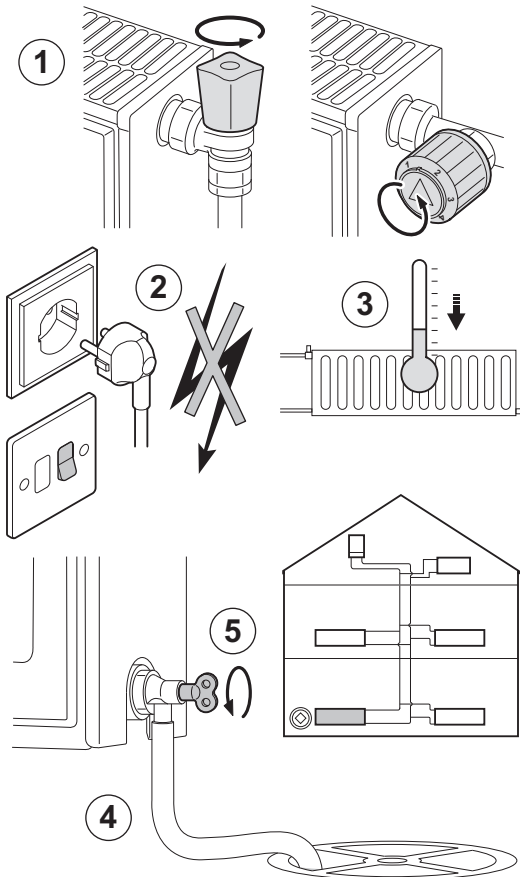

AD-3000488-A

It may be necessary to drain the central heating system if radiators need to be replaced, if there is a major water leak or if there is a risk of freezing. Proceed as follows:

1. Open the valves of all the radiators connected to the system.
2. Switch off the boiler's electrical connection.
3. Wait approximately 10 minutes, until the radiators feel cold.
4. Connect a drain hose to the lowest draining point. Place the end of the hose in a drain or at a place where drained pipe water will not cause any damage.
5. Open the central heating system fill/drain valve. Drain the installation.



### Warning

The water may still be hot.

6. Close the drain valve when no more water comes from the draining point.

## 8 Troubleshooting

### 8.1 Error codes

#### 8.1.1 Warning

If it is anticipated that a situation may develop into a fault, the boiler will first give a warning for some malfunctions. The display shows a warning code (e.g. **A02.33**).



##### Important

The boiler continues to operate but the cause of the warning must be investigated. A warning can result in the boiler becoming blocked or locked out.

#### 8.1.2 Blocking

A blocking is a (temporary) boiler status, resulting from an abnormal state. The display shows a blocking code (e.g. **H01.14**).

The boiler detects the changed status. If the cause of the blocking persists, the boiler will go into failure (lock) mode.



##### Important

- The boiler automatically returns to operation once the cause of the blocking has been removed.
- The boiler functions which are not blocked continue working.

#### 8.1.3 Lock-out

If the blocking conditions continue, the boiler goes into lockout (also called an error). The boiler will also lock out if an error is signalled anywhere in the boiler. The display flashes red and an error code is displayed (example: **E04.08**).



##### Important

The boiler only returns to operation if the causes of the lockout have been removed and a reset has been performed.

#### 8.1.4 Reporting error codes

If an error code does not disappear, contact the installer. Note down the following details before contacting the installer:

- Error code
- Gas type used
- Type of boiler
- Manufacturing date
- Serial no. of the appliance

This information can be found on the data plate that is affixed to the top of the boiler.

Fig.12 Data plate

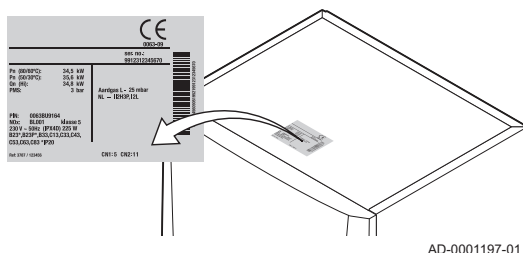

### 8.2 Reading the installer's name and phone number

The installer can set his name and phone number in the control panel. You can read this information when you want to contact the installer.

1. Press the button.
2. Select **System Settings** > .Installer Details  
⇒ The installer's name and phone number is shown.

### 8.3 Problems and solutions

Tab.24 Problems and solutions

Problem	Solution
There is no domestic hot water.	<ul style="list-style-type: none"> <li>• The boiler is not working:               <ul style="list-style-type: none"> <li>- Check that the boiler is being supplied with power.</li> <li>- Check the fuse and the switches.</li> <li>- Check whether the gas tap is properly open.</li> </ul> </li> <li>• The DHW function is switched off: switch the DHW function on.</li> </ul>
The radiators are cold.	<ul style="list-style-type: none"> <li>• The CH function is switched off: switch the CH function on.</li> <li>• The radiator valves are not open: open the valves on all radiators connected to the system.</li> <li>• The boiler is not working:               <ul style="list-style-type: none"> <li>- Check that the boiler is being supplied with power.</li> <li>- Check the fuses and the switches.</li> <li>- Check whether the gas tap is properly open.</li> </ul> </li> <li>• The water pressure is too low; top up the water in the system.</li> <li>• The temperature set point for the heating is too low: increase the value of parameter <b>CP010</b> or, if an ambient thermostat is connected, increase the temperature set on it.</li> </ul>
The boiler is not working.	<ul style="list-style-type: none"> <li>• No power supply:               <ul style="list-style-type: none"> <li>- Check that the boiler is being supplied with power.</li> <li>- Check the fuse and the switches.</li> </ul> </li> <li>• The boiler is blocked:               <ul style="list-style-type: none"> <li>- Check whether the gas valve is properly open: open the gas valve.</li> <li>- restart the boiler</li> <li>- If the blocking continues: Contact the installer:</li> </ul> </li> <li>• The boiler has broken down (lockout):               <ul style="list-style-type: none"> <li>- If the fault continues: Contact the installer:</li> </ul> </li> </ul>
The water pressure is too low (< 0.8 bar).	<ul style="list-style-type: none"> <li>• Too little water in the CH system: top up the system with water.</li> <li>• The automatic refill device (if fitted and set to automatic refilling) issues a warning because refilling is taking too long (<b>A02.33</b>) or is required too often (<b>A02.34</b>):               <ul style="list-style-type: none"> <li>- Check that the main water valve is fully open.</li> <li>- Check the boiler and system for leaks.</li> <li>- If the fault continues: Contact the installer.</li> </ul> </li> <li>• Water leakage. Contact the installer:</li> </ul>
Substantial fluctuations in the domestic hot water temperature.	Insufficient water supply: open the tap.
Unwanted noises from CH pipes/circuit.	<ul style="list-style-type: none"> <li>• There is air in the central heating pipes: any air in the boiler, the pipes or the valves must be removed in order to prevent unwanted noises that may occur during heating or when tapping water.</li> <li>• The water enters the CH system too quickly: contact the installer.</li> <li>• The brackets of the CH pipes have been over-tightened: contact the installer.</li> </ul>
Serious water leak under or close to the boiler.	<p>The boiler or central heating pipes are damaged:</p> <ul style="list-style-type: none"> <li>• Close the water supply.</li> <li>• Contact the installer:</li> </ul>

## 9 Disposal

### 9.1 Disposal and recycling

**Caution**

Only qualified professionals are permitted to remove and dispose of the boiler, in accordance with local and national regulations.

Fig.13



If you need to remove the boiler, proceed as follows:

1. Switch off the boiler.
2. Cut the power supply to the boiler.
3. Close the main gas valve.
4. Close the water mains.
5. Close the gas valve on the boiler.
6. Drain the installation.
7. Remove the air vent hose above the siphon.
8. Remove the siphon.
9. Remove the air/flue gas pipes.
10. Disconnect all pipes on the underside of the boiler.
11. Dismantle the boiler.

## 10 Environmental

### 10.1 Energy saving

---

- Keep the room in which the boiler is installed properly ventilated.
- Do not block ventilation outlets.
- Do not cover the radiators. Do not hang curtains in front of the radiators.
- Install reflector panels behind the radiators. These reflect heat that would otherwise be lost.
- Insulate the pipes in rooms that are not heated (cellars and lofts).
- Close the radiators in rooms not in use.
- Do not run hot (or cold) water pointlessly.
- Install an energy-saving shower head, which can save up to 40% energy.
- Take showers rather than baths; A bath consumes twice as much water and energy

#### 10.1.1 Room thermostats and settings

---

Various models of room thermostats are available. The thermostat type and setting affect the total energy consumption.

**A few tips:**

- A modulating regulator, which can also be combined with thermostatic radiator valves, is energy efficient and offers a high level of comfort. This combination allows the temperature to be set individually in each room. However, do not install thermostatic radiator valves in the room in which the room thermostat is located.
- Fully opening or closing thermostatic radiator valves results in unwanted temperature fluctuations. Turn the thermostat knob or valve higher or lower in small steps.
- Lower the thermostat to approximately 20°C. This reduces heating costs and energy consumption.
- When rooms are to be aired, lower the thermostat well in advance.
- Set the water temperature lower in the summer than in the winter (for example, 60°C and 80°C respectively) if an on/off thermostat is used.
- When setting clock thermostats and programmable thermostats, take account of days when nobody will be in and of holidays.



## 11 Warranty

### 11.1 General

---

We would like to thank you for buying one of our appliances and for your trust in our product.

In order to ensure continued safe and efficient operation, we recommend that the product is regularly inspected and maintained.

Your installer and our service department can assist with this.

### 11.2 Terms of warranty

---

The following provisions do not affect the application, in favour of the buyer, of the legal warranty in accordance with articles 1641 to 1648 of the civil code.

This appliance comes with a warranty that covers all manufacturing faults; the warranty period will commence on the date of purchase stated on the installer's invoice.

The warranty period is stated in our price list.

As a manufacturer, we can by no means be held liable if the appliance is used incorrectly, is poorly maintained or not maintained at all, or is not installed correctly (it is your responsibility to ensure that installation is carried out by a qualified installer).

In particular, we cannot be held liable for material damage, intangible losses or physical injury resulting from an installation that does not comply with:

- Legal or regulatory requirements or provisions laid down by the local authorities.
- National or local regulations and special provisions relating to the installation.
- Our manuals and installation instructions, in particular in terms of regular maintenance of the appliances.
- The rules of good workmanship.

Our warranty is limited to the replacement or repair of the parts found to be defective by our technical services team, excluding labour, transfer and transport costs.

Our warranty does not cover replacement or repair costs for parts that may become defective due to normal wear, incorrect usage, the intervention of unqualified third parties, inadequate or insufficient supervision or maintenance, a mains supply that is not appropriate or the use of unsuitable or poor quality fuel.

Smaller parts, such as motors, pumps, electrical valves etc., are guaranteed only if these parts have never been dismantled.

The rights established in European Directive 99/44/EEC, implemented by legal decree No. 24 of 2 February 2002 and published in Official Journal No. 57 of 8 March 2002, remain in force.

## 12 Appendix

### 12.1 ErP information

#### 12.1.1 Product fiche

Tab.25 Product fiche

De Dietrich - AMC		25/28 BIC	25/39 BIC
Space heating – Temperature application		Medium	Medium
Water heating – Declared load profile		XXL	XXL
Seasonal space heating energy efficiency class		<b>A</b>	<b>A</b>
Water heating energy efficiency class		<b>B</b>	<b>B</b>
Rated heat output ( <i>Prated or Psup</i> )	kW	25	25
Space heating – Annual energy consumption	GJ	76	78
Water heating – Annual energy consumption	kWh	64	65
	GJ	25	24
Seasonal space heating energy efficiency	%	94	92
Water heating energy efficiency	%	77	80
Sound power level $L_{WA}$ indoors	dB	52	46



**See**

For specific precautions in relation to assembly, installation and maintenance: Safety, page 5

### 12.1.2 Package fiche

Fig.14 Package fiche for boilers indicating the space heating energy efficiency of the package

**Seasonal space heating energy efficiency of boiler** ①  
'I' %

---

**Temperature control** ②  
 from fiche of temperature control +    %

Class I = 1%, Class II = 2%, Class III = 1.5%,  
 Class IV = 2%, Class V = 3%, Class VI = 4%,  
 Class VII = 3.5%, Class VIII = 5%

---

**Supplementary boiler** ③  
 from fiche of boiler (    - 'I' ) x 0.1 = ±    %

Seasonal space heating energy efficiency (in %)

---

**Solar contribution** ④  
 from fiche of solar device +    %

Collector size (in m<sup>2</sup>)

Tank volume (in m<sup>3</sup>)

Collector efficiency (in %)

$(\text{'III'} \times \text{  } + \text{'IV'} \times \text{  }) \times 0.9 \times (\text{  } / 100) \times \text{  } = + \text{  } \%$

Tank rating <sup>(1)</sup>  
 A\* = 0.95, A = 0.91,  
 B = 0.86, C = 0.83,  
 D - G = 0.81

(1) If tank rating is above A, use 0.95

---

**Supplementary heat pump** ⑤  
 from fiche of heat pump (    - 'I' ) x 'II' = +    %

Seasonal space heating energy efficiency (in %)

---

**Solar contribution AND Supplementary heat pump** ⑥  
 select smaller value 0.5 x    OR 0.5 x    = -    %

④

⑤

⑥

---

**Seasonal space heating energy efficiency of package** ⑦  
   %

---

**Seasonal space heating energy efficiency class of package**

<input type="checkbox"/>	<input type="checkbox"/>	<input type="checkbox"/>	<input type="checkbox"/>	<input type="checkbox"/>	<input type="checkbox"/>	<input type="checkbox"/>	<input type="checkbox"/>	<input type="checkbox"/>	<input type="checkbox"/>
G	F	E	D	C	B	A	A <sup>+</sup>	A <sup>++</sup>	A <sup>+++</sup>
<30%	≥30%	≥34%	≥36%	≥75%	≥82%	≥90%	≥98%	≥125%	≥150%

---

**Boiler and supplementary heat pump installed with low temperature heat emitters at 35°C ?** ⑦  
 from fiche of heat pump (    + (50 x 'II') =    %

---

The energy efficiency of the package of products provided for in this fiche may not correspond to its actual energy efficiency once installed in a building, as this efficiency is influenced by further factors such as heat loss in the distribution system and the dimensioning of the products in relation to building size and characteristics.

- I The value of the seasonal space heating energy efficiency of the preferential space heater, expressed in %.
- II The factor for weighting the heat output of preferential and supplementary heaters of a package as set out in the following table.
- III The value of the mathematical expression:  $294/(11 \cdot \text{Prated})$ , whereby 'Prated' is related to the preferential space heater.
- IV The value of the mathematical expression  $115/(11 \cdot \text{Prated})$ , whereby 'Prated' is related to the preferential space heater.

Tab.26 Weighting of boilers

<b>Psup / (Prated + Psup)<sup>(1)(2)</sup></b>	<b>II, package without hot water storage tank</b>	<b>II, package with hot water storage tank</b>
0	0	0
0.1	0.3	0.37
0.2	0.55	0.70
0.3	0.75	0.85
0.4	0.85	0.94
0.5	0.95	0.98
0.6	0.98	1.00
≥ 0.7	1.00	1.00
(1) The intermediate values are calculated by linear interpolation between the two adjacent values.		
(2) Prated is related to the preferential space heater or combination heater.		

Fig.15 Package fiche for combination heaters (boilers or heat pumps) indicating the water heating energy efficiency of the package

**Water heating energy efficiency of combination heater** ①  
 %

Declared load profile:

---

**Solar contribution** ②  
 from fiche of solar device Auxiliary electricity  
 $(1.1 \times \text{'I'} - 10\%) \times \text{'II'} - \text{'III'} - \text{'I'} = +$   %

---

**Water heating energy efficiency of package under average climate** ③  
 %

---

**Water heating energy efficiency class of package under average climate**

		<input type="checkbox"/>	<input type="checkbox"/>	<input type="checkbox"/>	<input type="checkbox"/>	<input type="checkbox"/>	<input type="checkbox"/>	<input type="checkbox"/>	<input type="checkbox"/>	<input type="checkbox"/>
		<b>G</b>	<b>F</b>	<b>E</b>	<b>D</b>	<b>C</b>	<b>B</b>	<b>A</b>	<b>A<sup>+</sup></b>	<b>A<sup>++</sup></b>
<input type="checkbox"/> <b>M</b>	<27%	≥27%	≥30%	≥33%	≥36%	≥39%	≥65%	≥100%	≥130%	≥163%
<input type="checkbox"/> <b>L</b>	<27%	≥27%	≥30%	≥34%	≥37%	≥50%	≥75%	≥115%	≥150%	≥188%
<input type="checkbox"/> <b>XL</b>	<27%	≥27%	≥30%	≥35%	≥38%	≥55%	≥80%	≥123%	≥160%	≥200%
<input type="checkbox"/> <b>XXL</b>	<28%	≥28%	≥32%	≥36%	≥40%	≥60%	≥85%	≥131%	≥170%	≥213%

---

**Water heating energy efficiency under colder and warmer climate conditions**

**Colder:** ③  
 - 0.2 x  =  %

**Warmer:** ③  
 + 0.4 x  =  %

The energy efficiency of the package of products provided for in this fiche may not correspond to its actual energy efficiency once installed in a building, as this efficiency is influenced by further factors such as heat loss in the distribution system and the dimensioning of the products in relation to building size and characteristics.

AD-3000747-01

- I The value of the water heating energy efficiency of the combination heater, expressed in %.
- II The value of the mathematical expression  $(220 \cdot Q_{ref})/Q_{nonsol}$ , where  $Q_{ref}$  is taken from Regulation EU 811/2013, Annex VII Table 15 and  $Q_{nonsol}$  from the product fiche of the solar device for the declared load profile M, L, XL or XXL of the combination heater.
- III The value of the mathematical expression  $(Q_{aux} \cdot 2.5)/(220 \cdot Q_{ref})$ , expressed in %, where  $Q_{aux}$  is taken from the product fiche of the solar device and  $Q_{ref}$  from Regulation EU 811/2013, Annex VII Table 15 for the declared load profile M, L, XL or XXL.



© Copyright

All technical and technological information contained in these technical instructions, as well as any drawings and technical descriptions supplied, remain our property and shall not be multiplied without our prior consent in writing. Subject to alterations.

DE DIETRICH

**FRANCE**

Direction de la Marque  
57, rue de la Gare - F-67580 Mertzwiller

☎ 03 88 80 27 00

✉ 03 88 80 27 99

[www.dedietrich-thermique.fr](http://www.dedietrich-thermique.fr)

VAN MARCKE

**BE**

Weggevoerdenlaan 5  
B- 8500 KORTRIJK

☎ +32 (0)56/23 75 11

[www.vanmarcke.be](http://www.vanmarcke.be)

DE DIETRICH THERMIQUE Iberia s.L.U

**ES**

C/Salvador Espriu, 11  
08908 L'HOSPITALET de LLOBREGAT

☎ +34 935 475 850

@ info@dedietrich-calefaccion.es

[www.dedietrich-calefaccion.es](http://www.dedietrich-calefaccion.es)

MEIER TOBLER AG

**CH**

Bahnstrasse 24 - CH - 8603 SCHWERZENBACH

☎ +41 (0) 44 806 41 41

@ info@meiertobler.ch

+41 (0)8 00 846 846 Serviceline

[www.meiertobler.ch](http://www.meiertobler.ch)

MEIER TOBLER SA

**CH**

Chemin de la Veyre-d'En-Haut B6,  
CH -1806 St-Légier-La-Chiésaz

☎ +41 (0) 21 943 02 22

@ info@meiertobler.ch

+41 (0)8 00 846 846 Serviceline

[www.meiertobler.ch](http://www.meiertobler.ch)

DE DIETRICH

Technika Grzewcza sp. z o.o.

**PL**

ul. Północna 15-19, 54-105 Wrocław

☎ +48 71 71 27 400

@ biuro@dedietrich.pl

801 080 881 Infocentrala  
0,35 zł / min

[www.facebook.com/DeDietrichPL](http://www.facebook.com/DeDietrichPL)

[www.dedietrich.pl](http://www.dedietrich.pl)

**De Dietrich**

SERVICE CONSOMMATEURS

0 825 120 520 Service 0,15 € / min  
+ prix appel

ООО «БДР ТЕРМИЯ Рус»

**RU**

129164, Россия, г. Москва  
Зубарев переулок, д. 15/1  
Бизнес-центр «Чайка Плаза», офис 309

☎ 8 800 333-17-18

✉ info@dedietrich.ru

[www.dedietrich.ru](http://www.dedietrich.ru)

NEUBERG S.A.

**LU**

39 rue Jacques Stas - B.P.12  
L- 2549 LUXEMBOURG

☎ +352 (0)2 401 401

[www.neuberg.lu](http://www.neuberg.lu)

[www.dedietrich-heating.com](http://www.dedietrich-heating.com)

DE DIETRICH SERVICE

**AT**

☎ 0800 / 201608 freecall

[www.dedietrich-heiztechnik.com](http://www.dedietrich-heiztechnik.com)

DUEDI S.r.l

**IT**

Distributore Ufficiale Esclusivo  
De Dietrich-Thermique Italia Via Passatore, 12  
12010 San Defendente di Cervasca CUNEO

☎ +39 0171 857170

✉ +39 0171 687875

@ info@duediclina.it

[www.duediclina.it](http://www.duediclina.it)

DE DIETRICH

**CN**

Room 512, Tower A, Kelun Building  
12A Guanghua Rd, Chaoyang District  
C-100020 BEIJING

☎ +86 (0)106 581 4017

+86 (0)106 581 4018

+86 (0)106 581 7056

✉ +86 (0)106 581 4019

@ contactBJ@dedietrich.com.cn

[www.dedietrich-heating.com](http://www.dedietrich-heating.com)

BDR THERMEA Czech Republic s.r.o

**CZ**

Jeseniova 2770/56 - 130 00 Praha 3

☎ +420 271 001 627

@ dedietrich@bdrthermea.cz

[www.dedietrich.cz](http://www.dedietrich.cz)



**De Dietrich**

