

Wall-hung gas condensing boilers

MCR-P 24/28 BIC PLUS



User Guide

Contents

1	Safety	4
	1.1 General safety instructions	4
	1.2 Recommendations	5
	1.3 Liabilities	6
	1.3.1 Manufacturer's liability	6
	1.3.2 Installer's liability	6
	1.3.3 User's liability	7
2	About this manual	8
	2.1 Symbols used	8
	2.2 Abbreviations	8
3	Technical specifications	9
	3.1 Homologations	9
	3.1.1 Certifications	9
	3.2 Technical specifications	9
4	Description of the product	12
	4.1 General description	12
5	Operation	13
	5.1 Control panel	13
	5.2 Commissioning the boiler	14
	5.3 Stopping the boiler	14
	5.4 Turning on the antifreeze function	14
	5.5 Changing the settings	15
	5.5.1 Changing the heating temperature	15
	5.5.2 Modifying the comfort setting (ECO)	16
	5.5.3 Stopping the central heating or activating the Summer mode	17
	5.5.4 Changing the domestic hot water temperature	18
	5.5.5 Stopping domestic hot water production	19
	5.5.6 Other settings	19

- 5.6 Reading out measured values21
- 6 Checking and maintenance22
 - 6.1 General instructions22
 - 6.2 Periodic checks22
 - 6.3 Filling the system23
 - 6.4 Bleeding the heating system24
- 7 Troubleshooting27
 - 7.1 Error codes27
 - 7.1.1 E01 - E02 - E07 - E0927
 - 7.1.2 E0427
 - 7.1.3 Other error codes27
 - 7.1.4 Before contacting the installer28
 - 7.2 Incidents and solutions29
- 8 Disposal30
 - 8.1 Disposal/Recycling30
- 9 Energy savings31
 - 9.1 Energy savings31
 - 9.1.1 Energy-saving advice31
 - 9.1.2 Room thermostat and settings31
- 10 Warranty33
 - 10.1 General33
 - 10.2 Warranty terms33
- 11 Appendix34
 - 11.1 ErP information34
 - 11.1.1 Product fiche34
 - 11.1.2 Package fiche35

1 Safety

1.1 General safety instructions



DANGER

This appliance can be used by children aged from 8 years and above and persons with reduced physical, sensory or mental capabilities or lack of experience and knowledge if they have been given supervision or instruction concerning use of the appliance in a safe way and understand the hazards involved. Children shall not play with the appliance. Cleaning and user maintenance shall not be made by children without supervision.



CAUTION

Only qualified persons are authorised to assemble, install and maintain the installation.



DANGER

If you smell gas:

1. Do not use a naked flame, do not smoke, do not operate electrical contacts or switches (doorbell, light, motor, lift, etc..).
2. Shut off the gas supply.
3. Open the windows.
4. Evacuate the premises.
5. Call your fitter.



DANGER

If you smell flue gases:

1. Switch the appliance off.
2. Open the windows.
3. Evacuate the premises.
4. Call your fitter.

**WARNING**

Depending on the settings of the appliance:

- ▶ The temperature of the flue gas conduits may exceed 60°C.
- ▶ The temperature of the radiators may reach 85°C.
- ▶ The temperature of the domestic hot water may reach 65°C.

**CAUTION**

Do not neglect to service the appliance:

- ▶ For completely safe and optimum operation, you must have your boiler regularly serviced by an approved installer.

1.2 Recommendations

**WARNING**

Only qualified professionals are authorised to work on the appliance and the installation.

- ▶ Regularly check the water pressure in the installation (minimum pressure 0.8 bar, recommended pressure between 0.8 and 1.5 bar).
- ▶ Keep the appliance accessible at all times.
- ▶ Never remove or cover labels and rating plates affixed to the appliance. Labels and rating plates must be legible throughout the entire lifetime of the appliance.
- ▶ The appliance should be on Summer or Antifreeze mode rather than switched off to guarantee the following functions:
 - Anti blocking of pumps
 - Antifreeze protection

1.3 Liabilities

1.3.1. Manufacturer's liability

Our products are manufactured in compliance with the requirements of the various applicable European Directives. They are therefore delivered with **CE** marking and all relevant documentation.

In the interest of customers, we are continuously endeavouring to make improvements in product quality. All the specifications stated in this document are therefore subject to change without notice.

Our liability as the manufacturer may not be invoked in the following cases:

- ▶ Failure to abide by the instructions on using the appliance.
- ▶ Faulty or insufficient maintenance of the appliance.
- ▶ Failure to abide by the instructions on installing the appliance.

1.3.2. Installer's liability

The installer is responsible for the installation and commissioning of the appliance. The installer must respect the following instructions:

- ▶ Read and follow the instructions given in the manuals provided with the appliance.
- ▶ Carry out installation in compliance with the prevailing legislation and standards.
- ▶ Perform the initial start up and carry out any checks necessary.
- ▶ Explain the installation to the user.
- ▶ If a maintenance is necessary, warn the user of the obligation to check the appliance and maintain it in good working order.
- ▶ Give all the instruction manuals to the user.

1.3.3. User's liability

To guarantee optimum operation of the appliance, the user must respect the following instructions:

- ▶ Read and follow the instructions given in the manuals provided with the appliance.
- ▶ Call on qualified professionals to carry out installation and initial start up.
- ▶ Get your installer to explain your installation to you.
- ▶ Ensure the Appliance is serviced in accordance with the manufacturer's instructions by a suitable qualified person.
- ▶ Keep the instruction manuals in good condition close to the appliance.

This appliance is not intended to be used by persons (including children) whose physical, sensory or mental capacity is impaired or persons with no experience or knowledge, unless they have the benefit, through the intermediary of a person responsible for their safety, of supervision or prior instructions regarding use of the appliance. Care should be taken to ensure that children do not play with the appliance.

If the mains power lead is damaged it must be replaced by the original manufacturer, the manufacturer's dealer or another competent person to prevent hazardous situations.

2 About this manual

2.1 Symbols used

In these instructions, various danger levels are employed to draw the user's attention to particular information. In so doing, we wish to safeguard the user's safety, highlight hazards and guarantee correct operation of the appliance.

**DANGER**

Risk of a dangerous situation causing serious physical injury.

**WARNING**

Risk of a dangerous situation causing slight physical injury.

**CAUTION**

Risk of material damage.



Signals important information.



Signals a referral to other instructions or other pages in the instructions.

2.2 Abbreviations

- ▶ **DHW:** Domestic hot water.
- ▶ **IRC:** Interactive remote control.
- ▶ **CRC:** Communicating remote controller.
- ▶ **Hi:** Lower heating value LHV (Nett).
- ▶ **Hs:** Higher heating value HHV (Gross).

3 Technical specifications

3.1 Homologations

3.1.1. Certifications

CE identification no	PIN 0063BQ3009
NOx	< 60 mg/kWh
Type of connection	Chimney: B ₂₃ Flue gas outlet: C ₁₃ , C ₃₃ , C ₄₃ , C ₅₃ , C ₆₃ , C ₈₃ , C ₉₃

3.2 Technical specifications

Boiler type		MCR-P BIC PLUS	
Nominal output (Pn) Heating System (80/60 °C)	minimum-maximum	kW	5,5 - 23,8
	Factory setting	kW	17,8
Nominal output (Pn) Heating System (50/30 °C)	minimum-maximum	kW	6,3 - 25,0
	Factory setting	kW	19,4
Nominal useful output (Pn) DHW	minimum-maximum	kW	5,5 - 27,4
	Factory setting	kW	27,4
Gas flow rate at nominal output (15 °C - 1013 mbar) (max)	Natural gas G20	m ³ /h	2,96
	Natural gas G25	m ³ /h	3,45
	Propane (G31)	m ³ /h	1,15
Heating efficiency under full load (Hi) (80/60 °C) (92/42/EEG)		%	99,1
Heating efficiency under full load (Hi) A/R=50/30 °C (EN15502)		%	104,4
Heating efficiency under partial load (Hi) (Return temperature 60°C)		%	94,3
Heating efficiency under partial load (Hi) (92/42/EEG)(Return temperature 30°C)		%	110,2
Heating efficiency under full load (Hs) (80/60 °C) (92/42/EEG)		%	89,3
Heating efficiency under full load (Hs) (50/30 °C) (EN15502)		%	94,0
Heating efficiency under partial load (Hs) (Return temperature 60°C)		%	84,9
Heating efficiency under partial load (Hs) (92/42/EEG)(Return temperature 30°C)		%	99,3
Weight empty, without mounting frame, without front cover		kg	67
Heating circuit			
Manometric height central heating circuit (ΔT = 20 K)		mbar ⁽¹⁾	240
Flow temperature		°C	75
Maximum temperature (Safety thermostat cut-off)		°C	110
Stand-by losses (ΔT = 30 °C)		W	86
Water operating pressure PMS max		bar (MPa)	3
(1) 1 mbar = 100 Pa, 1 daPa = 1 mmWG			
(2) Low temperature means for condensing boilers 30°C, for low temperature boilers 37°C and for other heaters 50°C return temperature (at heater inlet)			
(3) High temperature regime means 60°C return temperature at heater inlet and 80°C feed temperature at heater outlet			

Boiler type		MCR-P BIC PLUS	
Expansion vessel	litres		8
Initial pressure of the expansion vessel	bar (MPa)		1
Minimum operating pressure	bar (MPa)		0,8
Water content	litres		1,8
Domestic hot water circuit			
Instruction set outlet temperature	°C		60
Nominal max cold water pressure	bar (MPa)		8
Minimum pressure for 11 l/min	bar (MPa)		0,5
Water capacity	litres		40
Combustion products circuit			
Connection diameter	mm		60/100
Mass flue gas flow rate (min / max)	Kg/h		10/47
Flue gas temperature 80/60	°C		95
Pressure available at the flue gas nozzle	Pa ⁽¹⁾		100
Condensation water pH 50/30			1 - 7
Electricity characteristics			
Power supply voltage (50 Hz)	V		230
Power consumption	W		153
Electrical power circulating pump	W		128
Auxiliary electrical power (nominal output, ex heating pump)	W		25
Electrical protection index			IPX4D
Technical parameters			
Condensing boiler			Yes
Low-temperature boiler ⁽²⁾			No
B1 boiler			No
Cogeneration space heater			No
Combination heater			Yes
Rated heat output	<i>Prated</i>	kW	24
Useful heat output at rated heat output and high temperature regime ⁽³⁾	<i>P4</i>	kW	23,8
Useful heat output at 30% of rated heat output and low temperature regime ⁽²⁾	<i>P1</i>	kW	7,9
Seasonal space heating energy efficiency	η_s	%	94
Useful efficiency at rated heat output and high temperature regime ⁽³⁾	η_4	%	89,3
Useful efficiency at 30% of rated heat output and low temperature regime ⁽²⁾	η_1	%	99,3
Auxiliary electricity consumption			
Full load	<i>elmax</i>	kW	0,025
Partial load	<i>elmin</i>	kW	0,025
Standby mode	<i>P_{SB}</i>	kW	0,003
Other items			
Standby heat loss	<i>P_{stby}</i>	kW	0,057
Ignition burner power consumption	<i>P_{ign}</i>	kW	-
Annual energy consumption	<i>Q_{HE}</i>	kWh GJ	73
Sound power level, indoors	<i>L_{WA}</i>	dB	47
Emissions of nitrogen oxides	NO _x	mg/kWh	59
Domestic hot water parameters			
(1) 1 mbar = 100 Pa, 1 daPa = 1 mmWG			
(2) Low temperature means for condensing boilers 30°C, for low temperature boilers 37°C and for other heaters 50°C return temperature (at heater inlet)			
(3) High temperature regime means 60°C return temperature at heater inlet and 80°C feed temperature at heater outlet			

Boiler type		MCR-P BIC PLUS	
Declared load profile			XXL
Daily electricity consumption	Q_{elec}	kWh	0,231
Annual energy consumption	AEC	kWh	51
Water heating energy efficiency	η_{wh}	%	74
Daily fuel consumption	Q_{fuel}	kWh	32,373
Annual fuel consumption	AFC	GJ	26
(1) 1 mbar = 100 Pa, 1 daPa = 1 mmWG			
(2) Low temperature means for condensing boilers 30°C, for low temperature boilers 37°C and for other heaters 50°C return temperature (at heater inlet)			
(3) High temperature regime means 60°C return temperature at heater inlet and 80°C feed temperature at heater outlet			



See the back cover for contact details.

4 Description of the product

4.1 General description

Wall-hung gas condensing boilers



- ▶ Heating and domestic hot water production with integrated DHW tank.
- ▶ High efficiency heating.
- ▶ Low pollutant emissions.
- ▶ Flue gas discharge via a forced flue, chimney, bi-flow or 3CE type connection.

5 Operation

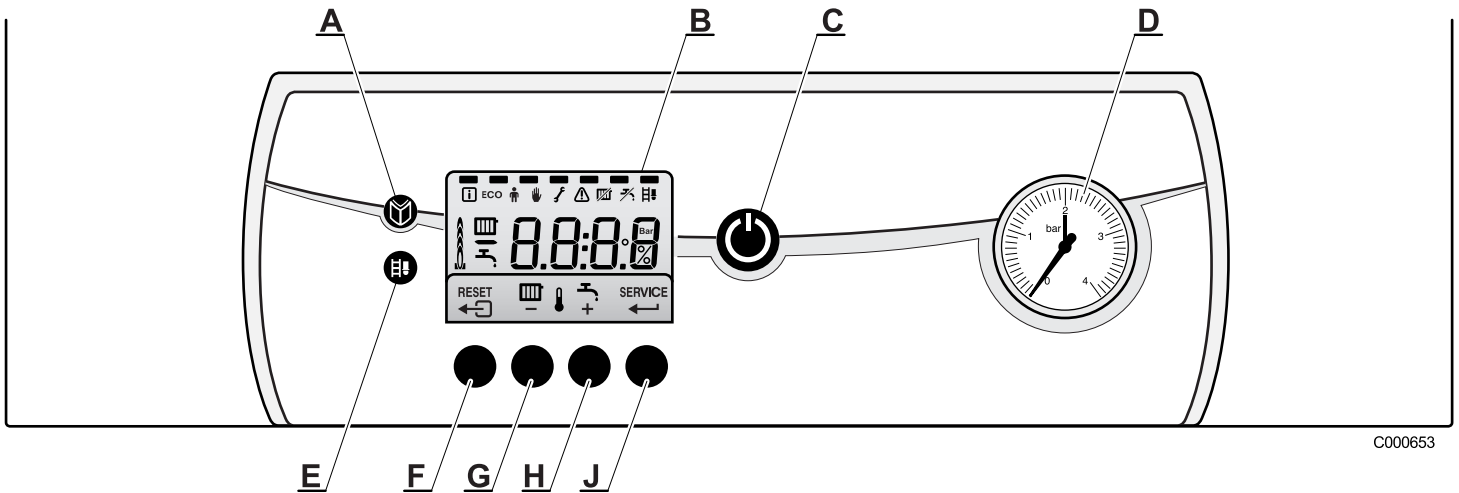
5.1 Control panel



C000653

- A** Menu key
- B** Display
- C** Main ON/OFF switch
- D** Pressure gauge
- E** Sweep key
- F**  or **RESET** key
- G** Heating temperature key or -
- H** DHW temperature key or +
- J** **SERVICE** or  key

The display indicates the state of the boiler and any errors. The symbols located above the function keys indicate their current function.

Pressing on any key will display the current status of the boiler and the current command code. If there is a fault, the corresponding code continues to be displayed.

5.2 Commissioning the boiler

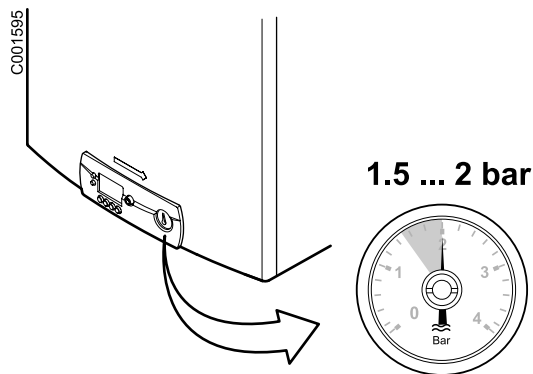

1. Check the water pressure in the installation.
2. Open the gas valve.

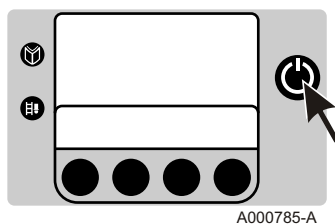

A000785-A

3. Throw the boiler's ON / OFF switch.
4. The start-up cycle begins. It lasts 2 minutes and cannot be interrupted.

During the start-up cycle, the display shows the following information:

F \square : XX : Software version

P \square : XX : Parameter version

The version numbers are displayed alternately.

5. When the start-up cycle is finished, the display shows \square . The boiler is now operational.

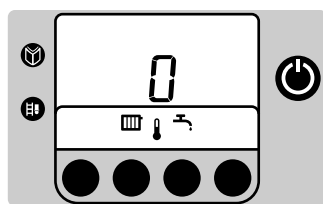

A000787-A

5.3 Stopping the boiler

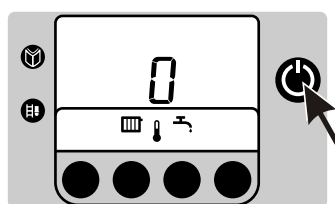

A000786-A

1. Throw the boiler's ON / OFF switch.
2. Switch off the boiler electrical power supply.
3. Close the gas valve.
4. Ensure that the boiler and system are protected against frost damage.

5.4 Turning on the antifreeze function

We recommend setting the boiler thermostat to a value off 10°C if using a classic installation.

Set the boiler to ECO mode using parameter P \square 4 , this action will switch off the standby setting.

Installation and room antifreeze protection is guaranteed if you are absent.

If the temperature of the central heating water in the boiler falls too much, the integrated protection device switches itself on:

- ▶ If the water temperature is lower than 7°C, the circulating pump is activated.
- ▶ If the water temperature is lower than 3°C, the boiler is activated.
- ▶ When the water temperature is above 10 °C, the boiler is switched off and the circulation pump runs for another 15 minutes.



CAUTION

This function is a protection device for the boiler only, not for the system or buiding fabric.



CAUTION

If a room thermostat, connected via connectors 7 and 8, is activated, the boiler will operate permanently until it reaches the flow setting point.

5.5 Changing the settings

5.5.1. Changing the heating temperature

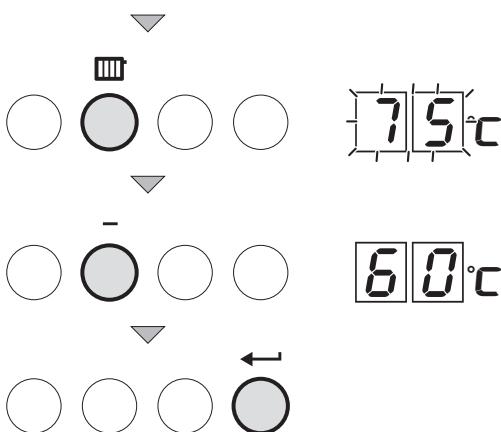
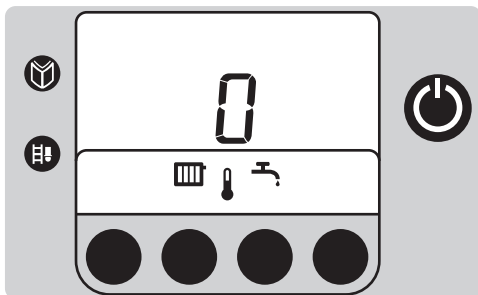

T000147-A



If an outside temperature sensor or an OpenTherm control system is fitted, the heating flow temperature is adjusted automatically.

In summer, it is possible to reduce the heating flow temperature whilst maintaining comfort. To do this, proceed as follows:

1. Press the **P** key.
The symbol **P** and the current temperature are displayed.
2. Use the **[+]** and **[-]** keys to change the parameter value.
3. To confirm the new value, press the key **←**.



It also possible to modify this setting using the parameter **P1**. See chapter: "Other settings", page 19.

5.5.2. Modifying the comfort setting (ECO)

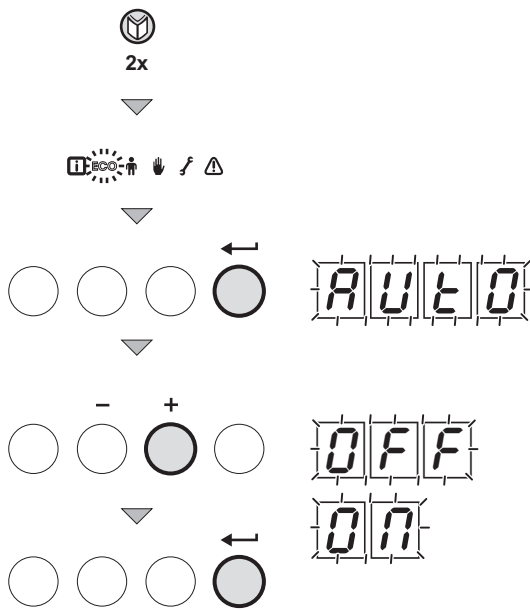

T000148-B

The user can consult or modify the following 3 settings:

- ▶ ON = Activation of the energy-saving setting.
- ▶ OFF = Activation of the comfort setting.
- ▶ AUTO = Setting dependent on the control unit (Factory setting).

1. Press the key 1 times. The symbol flashes.
2. Press the key a second time. The symbol **ECO** flashes.
3. To confirm, press the key.
4. The current operating status is shown on the display: **AUTO**.
5. Use the **+** and **-** keys to change the parameter value.
6. To confirm, press the key.
7. Press the key 2 times to return to the current operating mode.





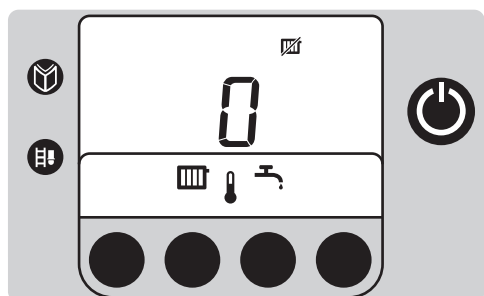
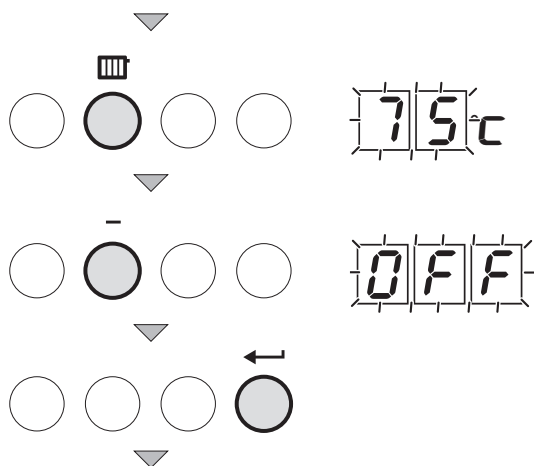
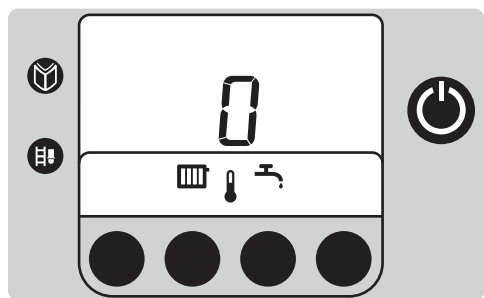

It also possible to modify this setting using the parameter .



5.5.3. Stopping the central heating or activating the Summer mode



T000141-A



1. Press the  key.
The symbol  and the current temperature are displayed.
 2. Press the key [-] several times until the value  is displayed.
 3. To confirm the new value, press the key .
- The symbol  appears.

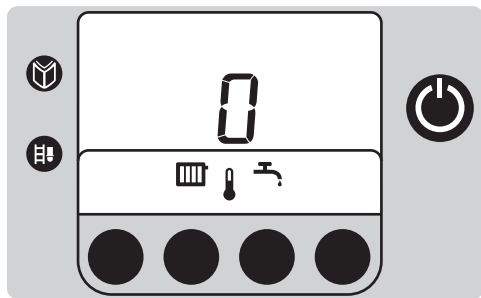

- ▶ It is also possible to modify this setting using the parameter .  See chapter: "Other settings", page 19.
- ▶ Domestic hot water production is maintained.

5.5.4. Changing the domestic hot water temperature



1. Press the  key.
The symbol  and the current temperature are displayed.
2. Use the **[+]** and **[-]** keys to change the parameter value.
3. To confirm the new value, press the key .



It also possible to modify this setting using the parameter

.

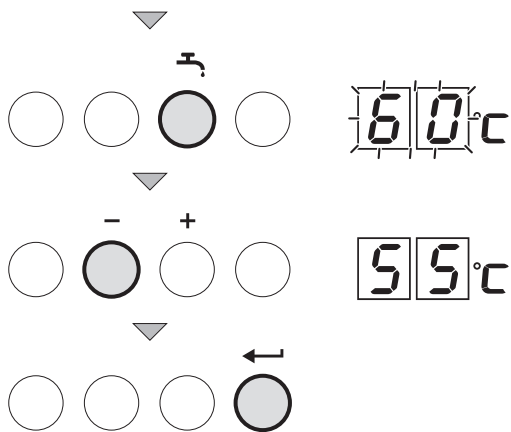

T000143-A

5.5.5. Stopping domestic hot water production

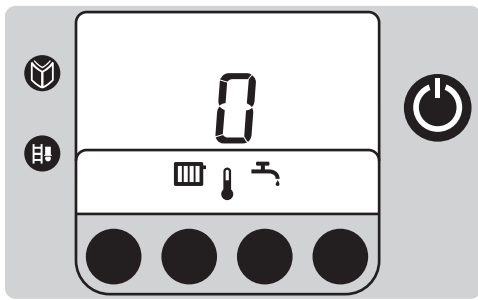

1. Press the key.
The symbol and the current temperature are displayed.
2. Press the key [-] several times until the value **0FF** is displayed.
3. To confirm the new value, press the key .

i It also possible to modify this setting using the parameter **P3**. See chapter: "Other settings", page 19.

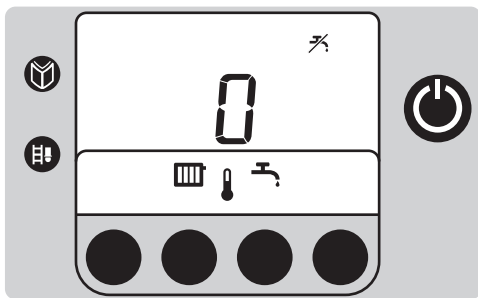
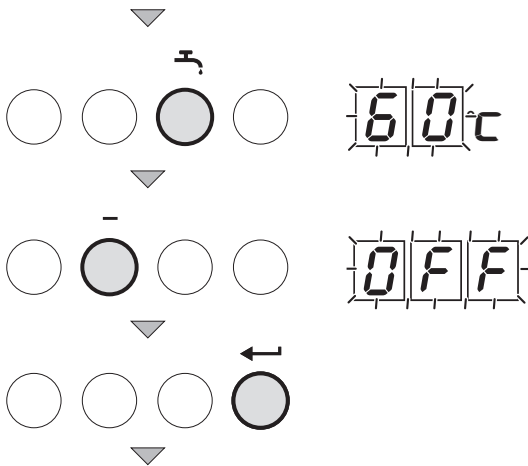

T000142-A

5.5.6. Other settings

Parameter	Description	Adjustment range	Factory setting
P1	Flow temperature	20 to 85 °C	75 °C
P2	Domestic hot water temperature	40 to 65 °C	60 °C
P3	Heating / DHW mode	0 = Heating deactivated () / DHW deactivated () 1 = Heating activated () / DHW activated () 2 = Heating activated () / DHW deactivated () 3 = Heating deactivated () / DHW activated ()	1
P4	ECO mode	0 = Comfort mode 1 = Energy-saving mode 2 = Management using a programmable thermostat	0
P5	Anticipation resistance	0 = No anticipation resistance for the ON/OFF thermostat 1 = Anticipation resistance for the ON/OFF thermostat	0
P6	Display screen	0 = The screen stays off 1 = The screen stays on 2 = The screen switches off automatically after 3 minutes	2

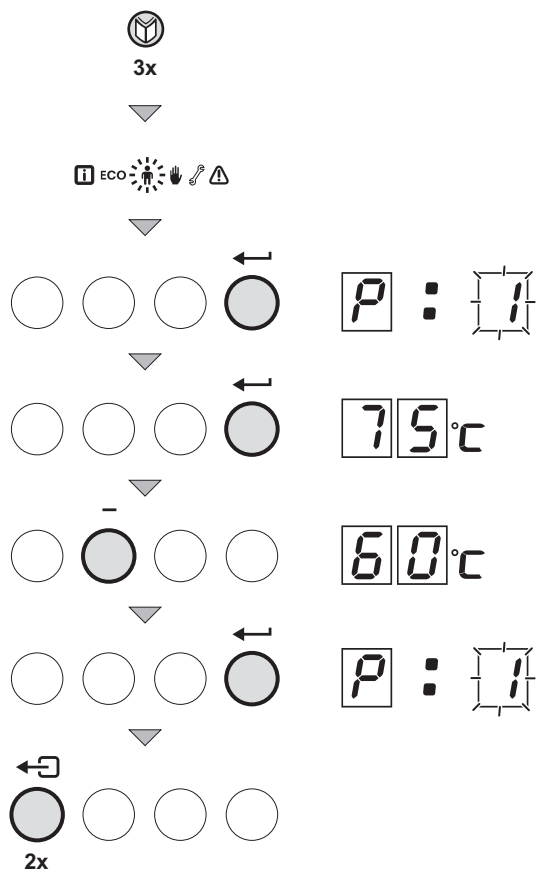

T000307-A

To change these parameters, proceed as follows:

1. Press key several times until the symbol flashes on the menu bar.
2. Press the key to enter the "User" menu.
The symbol appears.
3. Use the + and - keys to select to parameter to be changed.
4. Press the key to display the parameter value selected.
5. Use the + and - keys to change the parameter value.
6. To confirm the new value, press the key .
7. If necessary, set other parameters by selecting them using the + or - keys.
8. To exit the User menu, press the key 2 times.



If no selections are made in the various modes for 10 minutes, the boiler resumes the settings prior to manipulation.

5.6 Reading out measured values

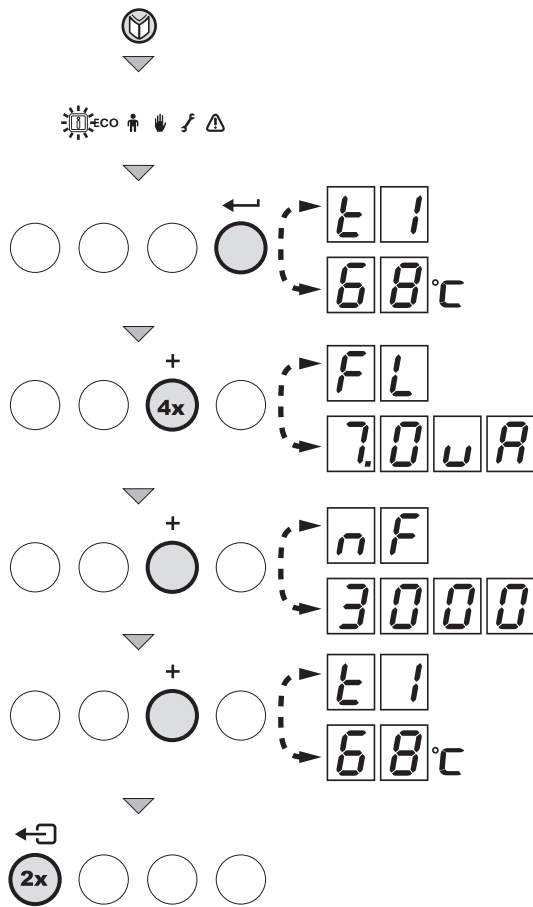

T000138-A

The following values can be displayed in the information menu **i**:

- ▶ **t1** = Flow temperature (°C)
- ▶ **t2** = Return temperature (°C)
- ▶ **t3** = DHW sensor temperature (°C)
This temperature is used only for internal management in DHW mode. During DHW draw-off, this value does not correspond to the actual DHW outlet temperature (it is always lower).
- ▶ **t4** = Outside temperature (°C)
- ▶ **FL** = Ionization current (µA)
- ▶ **nF** = Fan speed (rpm)

1. Press the **i** key. The symbol **i** flashes.
2. To access the parameters, press key ←.
3. Press the **+** key successively to scroll down the various parameters.
4. Press the ←↵ key 2 times to return to the current operating mode

6 Checking and maintenance

6.1 General instructions



CAUTION

- ▶ An annual inspection is compulsory.
- ▶ We recommend taking out a maintenance contract.
- ▶ Maintenance operations must be done by a qualified engineer.
- ▶ Only original spare parts must be used.
- ▶ Make certain that the flues and chimneys are connected, in good condition and not blocked.
- ▶ Do not modify nor block the condensate outlet(s).
- ▶ If a neutralisation system is installed, follow the instructions delivered with the neutralisation system for cleaning and servicing of this system.

6.2 Periodic checks

- ▶ Check the water pressure in the installation. If the water pressure is too low, add more water to the installation.  See chapter: "Filling the system", page 23.
- ▶ Carry out a visual check for the presence of any water leaks.
- ▶ Open and close the radiator valves several times a year (this prevents the valves from seizing up).

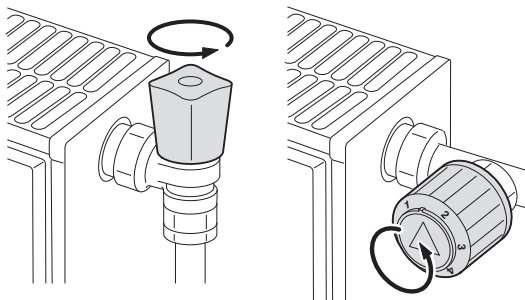

T000181-B

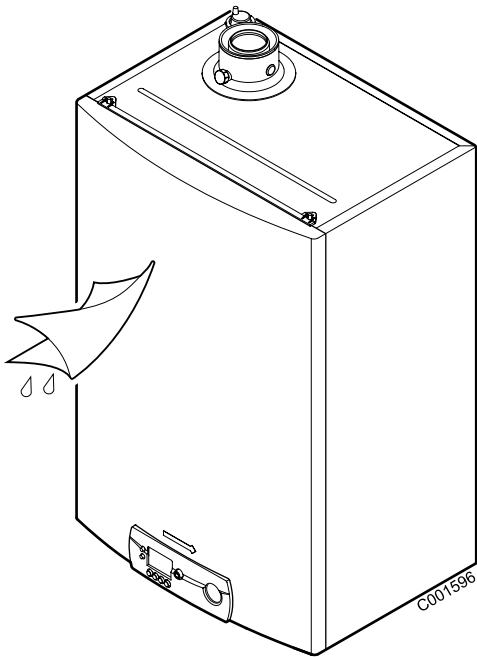

- ▶ Clean the outside of the boiler using a damp cloth and a light detergent.

**CAUTION**

Only a qualified professional is authorised to clean the inside of the boiler.

6.3 Filling the system

The water pressure in the boiler must be between 1,5 and 2 bar. Add water to the installation if necessary. To do this, proceed as follows:

1. Open the valves on all radiators connected to the heating system.

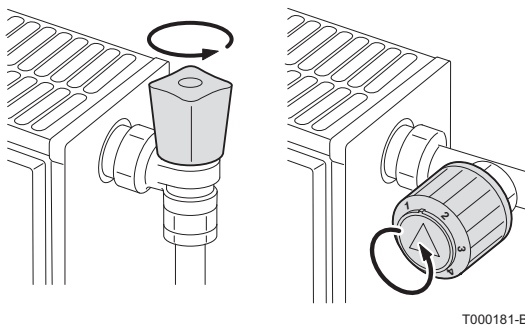

2. Set the room thermostat to as low a temperature as possible.

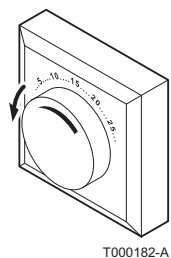

3. Switch off the boiler electrical power supply.

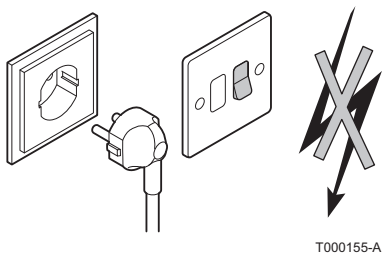

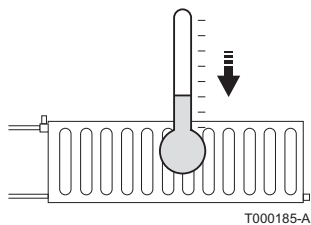

T000185-A

- Wait until the temperature drops below 40°C and the radiators seem cold before filling the central heating system.

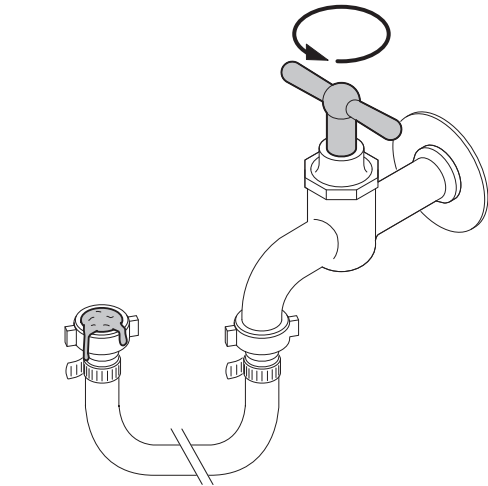

T000847-A

- Open the valve.
- Close the valve.
- After filling the installation, switch the boiler on.
- Set the room thermostat or the regulator.
- Set the radiator valves.

**CAUTION**

Filling and bleeding the installation 2 times a year should be sufficient to obtain an adequate hydraulic pressure. If it is often necessary to top up the installation with water, contact your fitter.

6.4 Bleeding the heating system

It is essential that you bleed any air in the calorifier, the conduits or the taps to prevent the annoying noises likely to be produced during heating or when tapping water. To do this, proceed as follows:

- Open the valves on all radiators connected to the heating system.

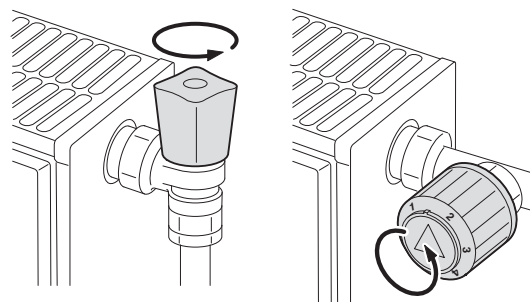

T000181-B

- Set the room thermostat as high as possible.

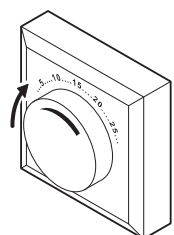

T000183-A

- Wait until the radiators are hot.

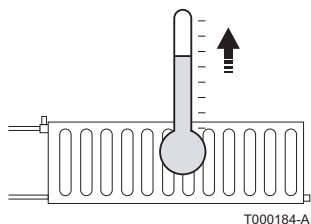

T000184-A

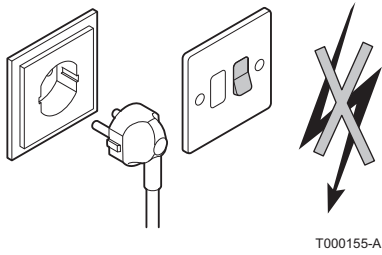

T000155-A

4. Switch the boiler off.

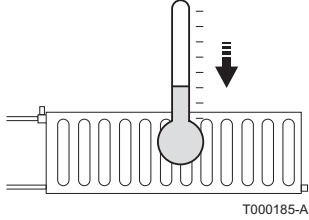

T000185-A

5. Wait around 10 minutes until the radiators are cold.

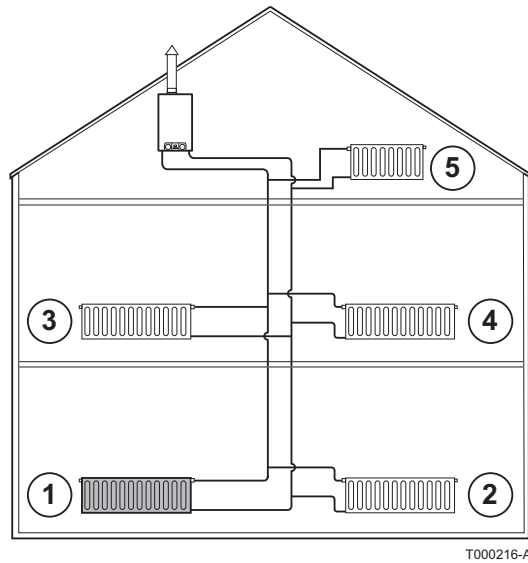

T000216-A

6. Bleed the radiators. Start with the lower floors.

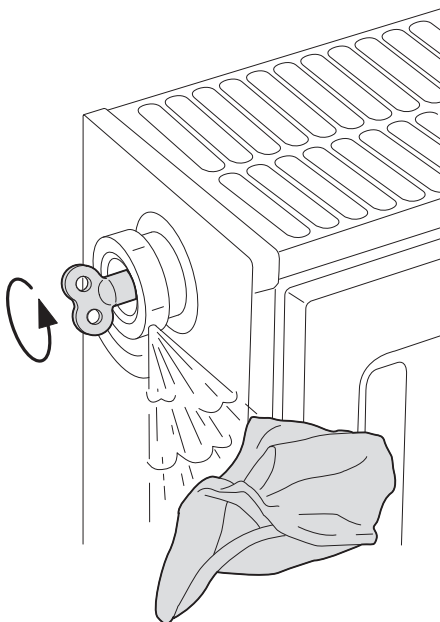

T000217-A

7. Open the bleed connection using the bleed key provided whilst keeping a rag pressed against the connection.

8. Wait until water comes out of the bleed valve and then close the bleed connection.

**CAUTION**

The water may still be hot.

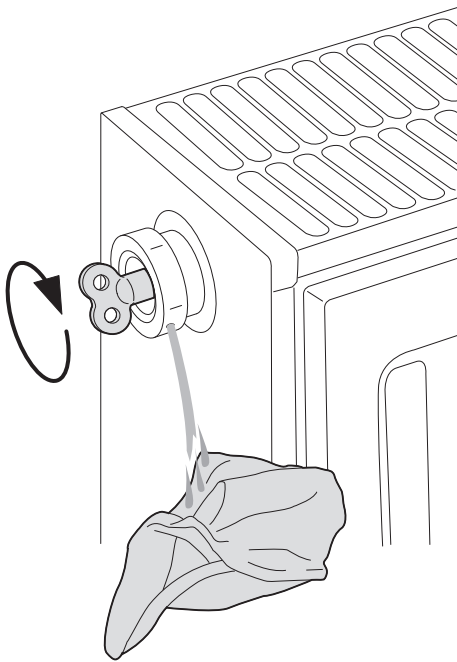

T000218-A

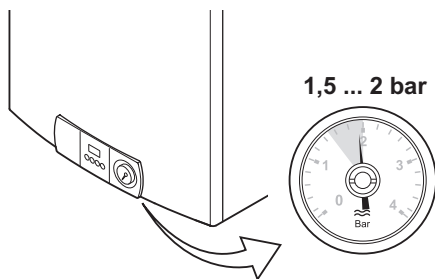

T000228-A

9. After venting, check whether the pressure in the installation is still sufficient. Add water to the installation if necessary.
10. Switch on the boiler. A vent cycle of a duration of around 3 minutes is carried out automatically.

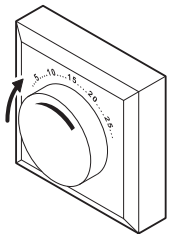

T000183-A

11. Set the room thermostat or the regulator.

7 Troubleshooting

7.1 Error codes

7.1.1. E01 - E02 - E07 - E09

E01 - E02 - E07 - E09

T004115-A

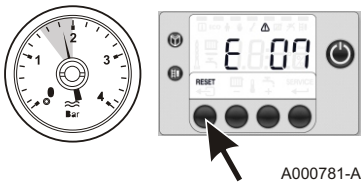

A000781-A

If one of the breakdown codes opposite is displayed, check the hydraulic pressure:

Case 1: Pressure higher than or equal to 1 bar

- ▶ Press the RESET key to reset the appliance. Wait a few seconds.
 - If the display shows **0**, the boiler is again operating normally.
 - If the display again shows **E1**, **E2** or **E7**, contact the installer.

Case 2: Pressure lower than 1 bar

- ▶ Top up the installation with water.  See chapter: "Filling the system", page 23.
- ▶ Press the RESET key to reset the appliance. Wait a few seconds.
 - If the display shows **0**, the boiler is again operating normally.
 - If the display again shows **E1**, **E2**, **E7** or **E9**, contact the installer.

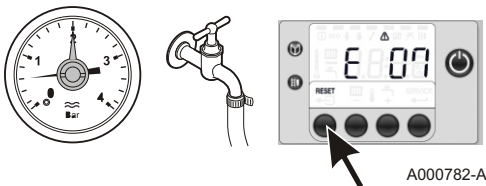

A000782-A

7.1.2. E04

If the breakdown code opposite is shown:

- ▶ Check the position of the gas valve. Open the gas valve if it is closed.
- ▶ Press the RESET key to reset the appliance. Wait a few seconds.
 - If the display shows **0**, the boiler is again operating normally.
 - If the display again shows **E4**, contact the installer.

E04

A000783-A

7.1.3. Other error codes

If another error code is displayed, contact the installer.

7.1.4. Before contacting the installer

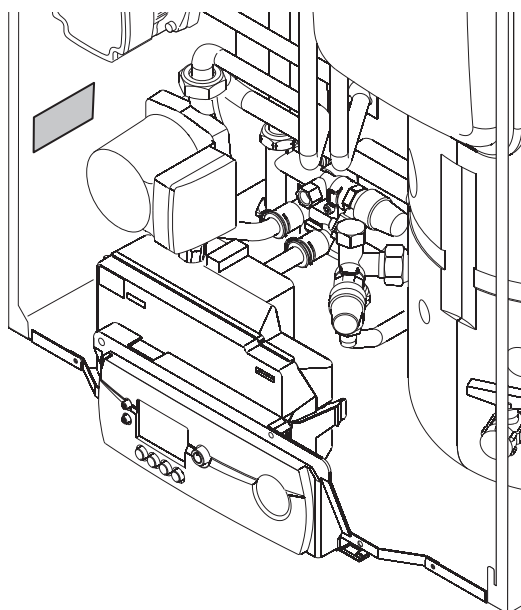







AD-0000686-01

Before contacting the installer

Note the following information on the appliance's rating plate:

- ▶ Type of gas used
- ▶ Boiler type
- ▶ Manufacturing date
- ▶ Serial no. of the appliance

7.2 Incidents and solutions

Problem	Probable causes	Solution
There is no domestic hot water.	The boiler is not switched on.	<ul style="list-style-type: none"> ▶ Check that the boiler is switched on. ▶ Check the fuses and switches. ▶ Check that the gas valve is fully opened.
	The DHW mode is deactivated.	Activate the DHW mode.
	The water pressure is too low (< 1 bar).	Top up the installation with water.  See chapter: "Filling the system", page 23.
	The energy-saving shower head is restricting the water flow.	Clean the shower head; replace if necessary.
The radiators are cold.	The heating temperature setting is too low.	Increase the value of parameter  or, if a room thermostat is connected, increase the temperature.
	The heating mode is deactivated.	Activate the heating mode.
	The radiator valves are closed.	Open the valves on all radiators connected to the heating system.
	The boiler is not switched on.	<ul style="list-style-type: none"> ▶ Check that the boiler is switched on. ▶ Check the fuses and switches. ▶ Check that the gas valve is fully opened.
	The water pressure is too low (< 1 bar).	Top up the installation with water.  See chapter: "Filling the system", page 23.
The boiler is not working.	The heating temperature setting is too low.	
	The boiler is not switched on.	<ul style="list-style-type: none"> ▶ Check that the boiler is switched on. ▶ Check the fuses and switches. ▶ Check that the gas valve is fully opened.
	The water pressure is too low (< 1 bar).	Top up the installation with water.  See chapter: "Filling the system", page 23.
	An error code appears on the display.	<ul style="list-style-type: none"> ▶ Press the Reset button for 2 seconds. ▶ Correct the error if possible.  See chapter: "Error codes", page 27.
	The gas pressure is too low.	Open the gas valve.
The water pressure is too low (< 1 bar).	Not enough water in the installation.	Top up the installation with water.  See chapter: "Filling the system", page 23.
	Water leak.	Contact the fitter.
Significant variations in domestic hot water temperature.	Insufficient water supply.	Open the valve.
Clicking in the central heating pipes	The central heating pipe connections are too tight.	Contact the fitter.
	There is air in the heating pipes.	It is essential that you bleed any air in the calorifier, the conduits or the taps to prevent the annoying noises likely to be produced during heating or when tapping water.
	The water is circulating too quickly in the central heating system.	Contact the fitter.
Significant water leak under or close to the boiler	The boiler or central heating pipes are damaged.	Close the water supply. Contact the fitter.

8 Disposal

8.1 Disposal/Recycling



Removal and disposal of the boiler must be carried out by a qualified professional in compliance with prevailing local and national regulations.

Follow the steps below to remove the boiler:

- ▶ Switch off the boiler electrical power supply.
- ▶ Shut off the gas supply.
- ▶ Close the water supply.
- ▶ Vent the heating installation.
- ▶ Remove the siphon.
- ▶ Remove the air and exhaust pipes.
- ▶ Disconnect all pipes from the boiler.
- ▶ Remove the boiler.

9 Energy savings

9.1 Energy savings

This chapter contains:

- ▶ Energy-saving advice
- ▶ Advice on setting the room thermostat correctly

9.1.1. Energy-saving advice

- ▶ Keep the room in which the boiler is installed well ventilated. Do not block ventilation outlets. Install reflective panels behind the radiators to prevent heat losses.
- ▶ Do not cover the radiators. Do not hang curtains in front of the radiators.
- ▶ Insulate the pipes in rooms that are not heated (cellars and lofts).
- ▶ Close the radiators in rooms not in use.
- ▶ Do not run hot (or cold) water pointlessly.
- ▶ Install a water-saving shower head to save up to 40 % energy.
- ▶ Take showers rather than baths. A bath consumes twice as much water and energy.

9.1.2. Room thermostat and settings

The room thermostat is available in the following versions:

- ▶ 2-wire ON/OFF thermostat
- ▶ Modulating thermostat
- ▶ Programmable room temperature thermostat

The type of thermostat and its settings have a considerable influence on energy consumption.

A few tips:

- ▶ A modulating thermostat, possibly in combination with thermostatic valve radiators, saves energy and offers considerable comfort. This combination allows you to set the temperature on each flow.
- ▶ Completely closing and opening thermostatic valve radiators causes undesirable temperature fluctuations. Open and close thermostatic valves in small steps.
- ▶ Lower the thermostat to around 20°C. This reduces heating costs and energy consumption.
- ▶ Lower the room thermostat when you air the rooms.

- ▶ If you are using an ON/OFF type thermostat, reduce the water temperature value (P/I) in summer (e.g. 60°C in summer and 80°C in winter).
- ▶ When setting an hourly programmable thermostat, keep in mind the days you are absent or on vacation.

10 Warranty

10.1 General

You have just purchased one of our appliances and we thank you for the trust you have placed in our products.

Please note that your appliance will provide good service for a longer period of time if it is regularly checked and maintained.

Your installer and our customer support network are at your disposal at all times.

10.2 Warranty terms

The following provisions are not exclusive of the buyer being able benefit from the legal provisions applicable regarding hidden defects in the buyer's country.

Starting from the purchase date shown on the original installer's invoice, your appliance has a contractual guarantee against any manufacturing defect.

The length of the guarantee is mentioned in the price catalogue. The manufacturer is not liable for any improper use of the appliance or failure to maintain or install the unit correctly (the user shall take care to ensure that the system is installed by a qualified engineer).

In particular, the manufacturer shall not be held responsible for any damage, loss or injury caused by installations which do not comply with the following:

- ▶ applicable local laws and regulations,
- ▶ specific requirements relating to the installation, such as national and/or local regulations,
- ▶ the manufacturer's instructions, in particular those relating to the regular maintenance of the unit,
- ▶ the rules of the profession.

The warranty is limited to the exchange or repair of such parts as have been recognised to be faulty by our technical department and does not cover labour, travel and carriage costs.

The warranty shall not apply to the replacement or repair of parts damaged by normal wear and tear, negligence, repairs by unqualified parties, faulty or insufficient monitoring and maintenance, faulty power supply or the use of unsuitable fuel.

Sub-assemblies such as motors, pumps, electric valves etc. are guaranteed only if they have never been dismantled.

The legislation laid down by european directive 99/44/EEC, transposed by legislative decree No. 24 of 2 February 2002 published in O.J. No. 57 of 8 March 2002, continues to apply.

11 Appendix

11.1 ErP information

11.1.1. Product fiche

DeDietrich - MCR - P BIC PLUS		24/28
Space heating - Temperature application		Medium
Water heating - Declared load profile		XXL
Seasonal space heating energy efficiency class		A
Water heating energy efficiency class		B
Rated heat output (Prated of Psup)	kW	24
Space heating - Annual energy consumption	GJ	73
Water heating - Annual energy consumption	kWh GJ	51 26
Seasonal space heating energy efficiency	%	94
Water heating energy efficiency	%	74
Sound power level L _{WA} indoors	dB	47

For specific precautions about assembling, installing and maintaining:

 "General safety instructions", page 4

11.1.2. Package fiche

Package card for boilers stating the energy efficiency for central heating for the package

Seasonal space heating energy efficiency of boiler

①
'I' %

Temperature control

from fiche of temperature control

Class I = 1%, Class II = 2%, Class III = 1.5%,
 Class IV = 2%, Class V = 3%, Class VI = 4%,
 Class VII = 3.5%, Class VIII = 5%

②
 + %

Supplementary boiler

from fiche of boiler

Seasonal space heating energy efficiency (in %)

③
 $(\text{ } - \text{'I'}) \times 0.1 = \pm \text{ } \%$

Solar contribution

from fiche of solar device

Collector size (in m²)

Tank volume (in m³)

Collector efficiency (in %)

Tank rating ⁽¹⁾
 A* = 0.95, A = 0.91,
 B = 0.86, C = 0.83,
 D - G = 0.81

④
 $(\text{'III'} \times \text{ } + \text{'IV'} \times \text{ }) \times 0.9 \times (\text{ } / 100) \times \text{ } = + \text{ } \%$

(1) If tank rating is above A, use 0.95

Supplementary heat pump

from fiche of heat pump

Seasonal space heating energy efficiency (in %)

⑤
 $(\text{ } - \text{'I'}) \times \text{'II'} = + \text{ } \%$

Solar contribution AND Supplementary heat pump

select smaller value

⑥
 $0.5 \times \text{ } \text{ OR } 0.5 \times \text{ } = - \text{ } \%$

Seasonal space heating energy efficiency of package

⑦
 %

Seasonal space heating energy efficiency class of package

<input type="checkbox"/>	<input type="checkbox"/>	<input type="checkbox"/>	<input type="checkbox"/>	<input type="checkbox"/>	<input type="checkbox"/>	<input type="checkbox"/>	<input type="checkbox"/>	<input type="checkbox"/>	<input type="checkbox"/>
G	F	E	D	C	B	A	A⁺	A⁺⁺	A⁺⁺⁺
<30%	≥30%	≥34%	≥36%	≥75%	≥82%	≥90%	≥98%	≥125%	≥150%

Boiler and supplementary heat pump installed with low temperature heat emitters at 35°C ?

from fiche of heat pump

⑦
 $\text{ } + (50 \times \text{'II'}) = \text{ } \%$

The energy efficiency of the package of products provided for in this fiche may not correspond to its actual energy efficiency once installed in a building, as this efficiency is influenced by further factors such as heat loss in the distribution system and the dimensioning of the products in relation to building size and characteristics.

- I The value of the seasonal space heating energy efficiency of the preferential space heater, expressed in %.
- II The factor for weighting the heat output of preferential and supplementary heaters of a package as set out in the following table.
- III The value of the mathematical expression: $294 / (11 \cdot \text{Prated})$, whereby (Prated) is related to the preferential space heater.
- IV The value of the mathematical expression: $115 / (11 \cdot \text{Prated})$, whereby (Prated) is related to the preferential space heater.

$P_{\text{sup}} / (P_{\text{rated}} + P_{\text{sup}})^{(1)(2)}$	II, package without hot water storage tank	II, package with hot water storage tank
0	0	0
0,1	0,3	0,37
0,2	0,55	0,70
0,3	0,75	0,85
0,4	0,85	0,94
0,5	0,95	0,98
0,6	0,98	1,00
$\geq 0,7$	1,00	1,00

(1) The intermediate values are calculated by linear interpolation between the two adjacent values
(2) Prated is related to the preferential space heater or combination heater

Package card for combination heating appliances (boilers or heat pumps) stating the energy efficiency for water heating for the package

Water heating energy efficiency of combination heater

①
 %

Declared load profile:

Solar contribution

from fiche of solar device

Auxiliary electricity

②
 $(1.1 \times 'I' - 10\%) \times 'II' - 'III' - 'I' = +$ %

Water heating energy efficiency of package under average climate

③
 %

Water heating energy efficiency class of package under average climate

	<input type="checkbox"/>	<input type="checkbox"/>	<input type="checkbox"/>	<input type="checkbox"/>	<input type="checkbox"/>	<input type="checkbox"/>	<input type="checkbox"/>	<input type="checkbox"/>	<input type="checkbox"/>	<input type="checkbox"/>
	G	F	E	D	C	B	A	A⁺	A⁺⁺	A⁺⁺⁺
<input type="checkbox"/> M	<27%	≥27%	≥30%	≥33%	≥36%	≥39%	≥65%	≥100%	≥130%	≥163%
<input type="checkbox"/> L	<27%	≥27%	≥30%	≥34%	≥37%	≥50%	≥75%	≥115%	≥150%	≥188%
<input type="checkbox"/> XL	<27%	≥27%	≥30%	≥35%	≥38%	≥55%	≥80%	≥123%	≥160%	≥200%
<input type="checkbox"/> XXL	<28%	≥28%	≥32%	≥36%	≥40%	≥60%	≥85%	≥131%	≥170%	≥213%

Water heating energy efficiency under colder and warmer climate conditions

Colder: ^③ - 0.2 x ^② = %

Warmer: ^③ + 0.4 x ^② = %

The energy efficiency of the package of products provided for in this fiche may not correspond to its actual energy efficiency once installed in a building, as this efficiency is influenced by further factors such as heat loss in the distribution system and the dimensioning of the products in relation to building size and characteristics.

AD-3000747-01

- I The value of the water heating energy efficiency of the combination heater, expressed in %.
- II .The value of the mathematical expression $(220 * Q_{ref}) / Q_{nonsol}$, where Q_{ref} is taken from Regulation EU 811/2013, Annex VII Table 15 and Q_{nonsol} from the product fiche of the solar device for the declared load profile M, L, XL or XXL of the combination heater.

- III The value of the mathematical expression $(Q_{aux} \cdot 2,5) / (220 \cdot Q_{ref})$, expressed in %, where Q_{aux} is taken from the product fiche of the solar device and Q_{ref} from Regulation EU 811/2013, Annex VII Table 15 for the declared load profile M, L, XL or XXL.

DE DIETRICH THERMIQUE S.A.S

www.dedietrich-thermique.fr
 Direction des Ventes France
 57, rue de la Gare
 F- 67580 MERTZWILLER
 ☎ +33 (0)3 88 80 27 00
 📠 +33 (0)3 88 80 27 99



SP



OpenTherm®

REMEHA GmbH

www.remeha.de
 Rheiner Strasse 151
 D- 48282 EMSDETTEN
 ☎ +49 (0)25 72 / 9161-0
 📠 +49 (0)25 72 / 9161-102
 info@remeha.de

**DE DIETRICH**

www.dedietrich-otoplenie.ru
 129164, Россия, г. Москва
 Зубарев переулок, д. 15/1
 Бизнес-центр «Чайка Плаза»,
 офис 309
 ☎ +7 (495) 221-31-51
 info@dedietrich.ru

**VAN MARCKE**

www.vanmarcke.be
 Weggevoerdenlaan 5
 B- 8500 KORTRIJK
 ☎ +32 (0)56/23 75 11

**NEUBERG S.A.**

www.dedietrich-heating.com
 39 rue Jacques Stas
 L- 2010 LUXEMBOURG
 ☎ +352 (0)2 401 401

**DE DIETRICH THERMIQUE Iberia S.L.U.**

www.dedietrich-calefaccion.es
 C/Salvador Espriu, 11
 08908 L'HOSPITALET de LLOBREGAT
 ☎ +34 935 475 850
 info@dedietrich-calefaccion.es

**DE DIETRICH SERVICE**

www.dedietrich-heiztechnik.com
 ☎ Freecall 0800 / 201608

**WALTER MEIER (Klima Schweiz) AG**

www.waltermeier.com
 Bahnstrasse 24
 CH-8603 SCHWERZENBACH
 +41 (0) 44 806 44 24
 Serviceline +41 (0)8 00 846 846
 ☎ +41 (0) 44 806 44 25
 ch.klima@waltermeier.com

**WALTER MEIER (Climat Suisse) SA**

www.waltermeier.com
 Z.I. de la Veyre B, St-Légier
 CH-1800 VEVEY 1
 ☎ +41 (0) 21 943 02 22
 Serviceline +41 (0)8 00 846 846
 ☎ +41 (0) 21 943 02 33
 ch.climat@waltermeier.com

DUEDI S.r.l.

www.duediclima.it
 Distributore Ufficiale Esclusivo
 De Dietrich-Thermique Italia
 Via Passatore, 12 - 12010
 San Defendente di Cervasca
 CUNEO
 ☎ +39 0171 857170
 📠 +39 0171 687875
 info@duediclima.it

**DE DIETRICH**

www.dedietrich-heating.com
 Room 512, Tower A, Kelun Building
 12A Guanghua Rd, Chaoyang District
 C-100020 BEIJING
 ☎ +86 (0)106.581.4017
 +86 (0)106.581.4018
 +86 (0)106.581.7056
 ☎ +86 (0)106.581.4019
 contactBJ@dedietrich.com.cn

**BDR Thermea (Czech republic) s.r.o**

www.dedietrich.cz
 Jeseniova 2770/56
 130 00 Praha 3
 ☎ +420 271 001 627
 info@dedietrich.cz



AD001NU-AQ

© Copyright

All technical and technological information contained in these technical instructions, as well as any drawings and technical descriptions supplied, remain our property and shall not be multiplied without our prior consent in writing.

170915



127686

De Dietrich

DE DIETRICH THERMIQUE

57, rue de la Gare F- 67580 MERTZWILLER - BP 30